

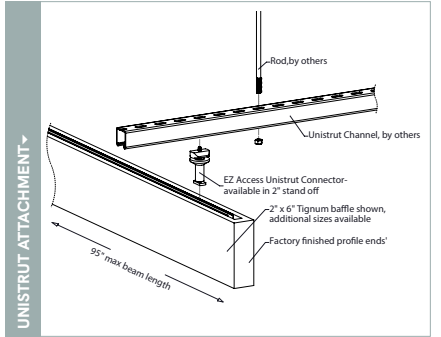

Tignum Traditional offers clean linear styling in a light weight, high strength, ultra durable baffle.

**MAIN ASSEMBLY**

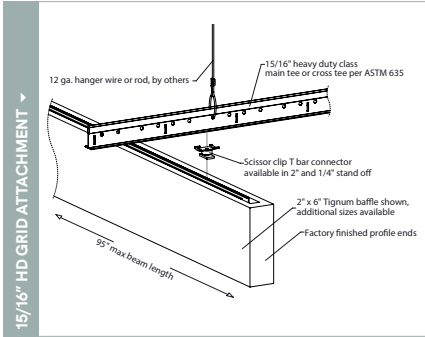
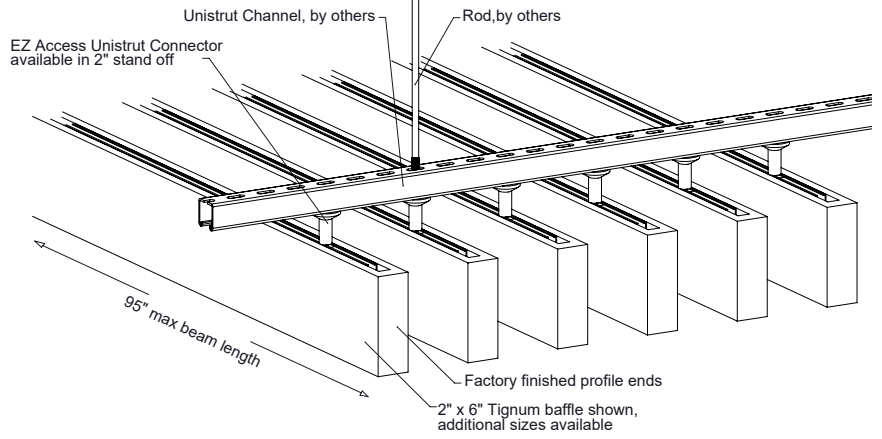

**PHYSICAL DATA**

- Material - Engineered wood panel with fire retardant MDF frame, wood veneer and aluminum channel
- Thickness - widths from 1-1/2" up to 3"
- Fire Performance - Can be manufactured Class A: Tested per ASTM E84. Flame Spread Index 25 or less. Smoke Developed Index 50 or less. CAN/ULC S102 surface burning characteristics. Flame Spread Rating 25 or less. Smoke Developed Class 50 or less.
- Weight - Approximately .75 - 1.28 lbs./In.ft.
- Warranty - One Year Limited
- Appearance - Variation among baffles may occur due to the naturally occurring characteristics of the wood and grain.
- Application - Tignum components must be acclimatized prior to installation and installed only after reaching equilibrium moisture content. Relative humidity between 25% and 55% and temperatures between 50°F and 86°F must be maintained.
- Seismic areas - Tignum has been engineered for use in all seismic areas. Installations may require additional attachment from baffle to suspension bar. Check with local code officials or a licensed engineer for additional requirements.
- Surface Finish - Clear or tinted semi-gloss coating

**SUSTAINABILITY**

**CONTRIBUTES TO LEED® POINTS -**

- LEED BD+C: New Construction v4
  - ▶ MR: Regional Materials
  - ▶ MR: Recycled Content
- LEED BD+C: Healthcare v4
  - ▶ MR: Design for Flexibility
- LEED BD+C: New Constructon v4.1
  - ▶ MR: Sourcing of Raw Materials
  - ▶ MR: Bio-based Materials
- LEED ID+C: Commercial Interiors v4
  - ▶ EQ: Low-Emitting Materials
- No VOC'S: No added urea - formaldehyde
- FSC chain of custody veneers available
- Recycled Content

LEED® is a registered trademark of the U.S. Green Building Council

**FEATURES**

- Unique lightweight / high strength design enables larger sizes than other wood baffles
- Durable MDF frame resists moisture, warping
- Available with micro perforated veneer and sound absorbing core for enhances acoustic comfort.
- 42 'Quick Ship' wood veneers plus any commercially available veneer
- 16 standard stains and custom stain matching
- Quick ship and expedited shipping
- Cleanable using CDC recommended and EPA-approved disinfectants for fog, spray & wipe
- Custom sizes & shapes - At Maxxit custom is what we do best. We will make any shape or size you can design
- Standard sizes - in addition to custom we also have quick ship standard products available made to order
  - ▶ Lengths - up to 8' (nominal)
  - ▶ Depths - 4", 6", 8", 10" & 12"
  - ▶ Widths - 1-1/2" & 2"
- Lightweight, pre-assembled & easy to install
- Versatile attachment options for Unistrut, 15/16" HD Grid and Cable hung applications
- Easy plenum access - attachment hardware allows baffles to slide for easy plenum access and adjustment during installation

# FINISHES

## Wood Veneers



**Khaya Mahogany**  
Flat Cut  
Variation - High

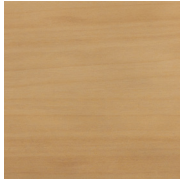

**Anegre**  
Flat Cut  
Variation - Medium



**White Oak Heavy Flake**  
Quarter Cut  
Variation - Medium



**Natural Bamboo**  
Quarter Cut  
Variation - Medium



**Western Red Cedar**  
Quarter Cut  
Variation - High



**Cherry**  
Flat Cut  
Variation - High



**White Oak**  
Quarter Cut  
Variation - Medium



**Red Oak**  
Quarter Cut  
Variation - Medium

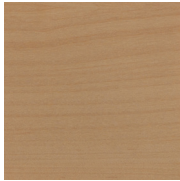

**Maple**  
Quarter Cut  
Variation - High



**White Ash**  
Quarter Cut  
Variation - Medium



**Hemlock**  
Quarter Cut  
Variation - Medium



**Euro Steamed Beech**  
Flat Cut  
Variation - Medium



**Birch**  
Flat Cut  
Variation - Medium



**Walnut**  
Quarter Cut  
Variation - Medium

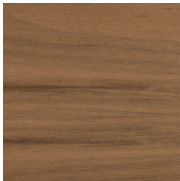

**Walnut**  
Flat Cut  
Variation - Medium



**English Sycamore**  
Quarter Cut  
Variation - Medium

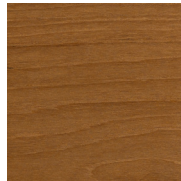

**Teak**  
Flat Cut  
Variation - Medium

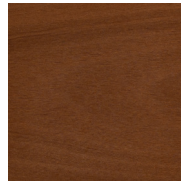

**Sapele**  
Flat Cut  
Variation - Medium



**Clear Pine**  
Flat Cut  
Variation - Medium



**Carbonized Bamboo**  
Quarter Cut  
Variation - Medium

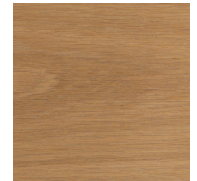

**White Oak**  
Flat Cut  
Variation - Medium



**Textured Oak  
Saw Cut D1**  
Variation - Medium



**Textured Oak Grey  
Saw Cut D3**  
Variation - Medium



**Textured Dark Walnut**  
Engineered  
Variation - Medium

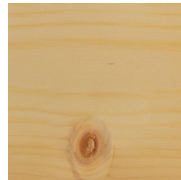

**Knotty Pine**  
Flat Cut  
Variation - Medium

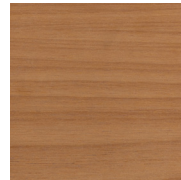

**Red Alder**  
Flat Cut  
Variation - Medium



**Aromatic Red Cedar**  
Flat Cut  
Variation - High

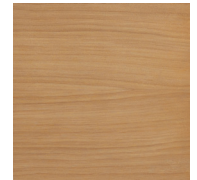

**Red Birch**  
Flat Cut  
Variation - Medium

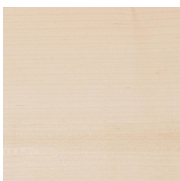

**White Maple**  
Engineered  
Variation - Medium



**VG Fir**  
Engineered  
Variation - Medium



**Gun Metal Ebony**  
Engineered  
Variation - Medium



**Napa Weathered Oak**  
Engineered  
Variation - Medium



**Monterey Weathered Oak**  
Engineered  
Variation - Medium



**Santa Monica**  
Engineered  
Variation - Medium



**Slate**  
Engineered  
Variation - Medium



**Zebrano**  
Engineered  
Variation - Medium

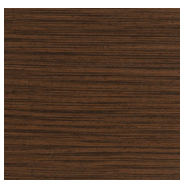

**Wenge**  
Engineered  
Variation - Medium

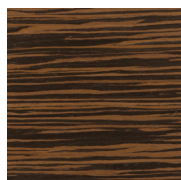

**Ebony**  
Engineered  
Variation - Medium



**Cherry**  
Engineered  
Variation - Medium



**Teak**  
Engineered  
Variation - Medium



**White Oak**  
Engineered  
Variation - Medium

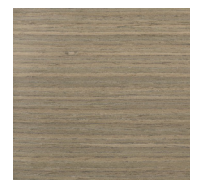

**Walnut**  
Engineered  
Variation - Medium

# FINISHES

## Standard Stains

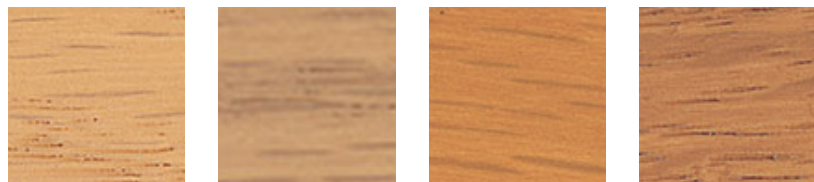

Natural Beige

Desert Sand

Honey Comb

Cocoa



Cinnamon

English Oak

Harvest Gold

Colonial Pine



Vermont Maple

Cinnamon Toast

Dutch Chocolate

Rosewood

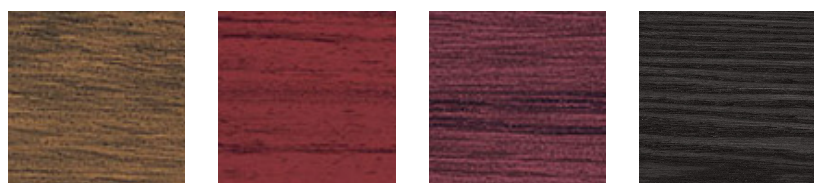

American Walnut

Antique Red

Burgundy

Onyx

## Custom Colors

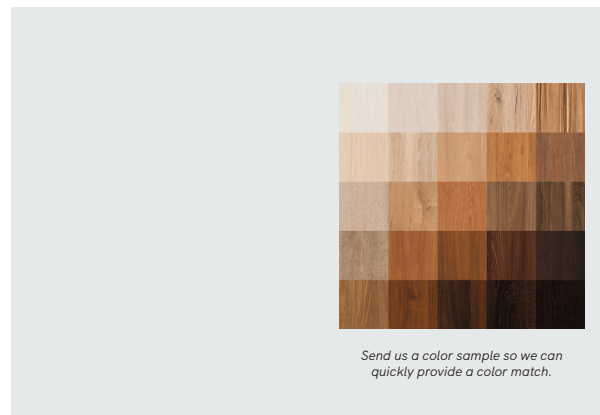



# TIGNUM DESIGNS

ELEVATIONS ▾



SHUFFLE ▾



NETWORKS ▾



PARTITIONS ▲



WALL SLATS ▲



TRADITIONAL ▲

# DESIGN REALIZED

From the familiar to the truly one of a kind, Maxxit brings your design vision to life. With ceilings and walls crafted from Wood, Felt, Metal, Composites & more there is no limit to what we can create together.

