

Agilis Networks features interconnected beams that form shapes from traditional cubes to bespoke designs in floating and wall to wall configurations.

MAIN ASSEMBLY ▾

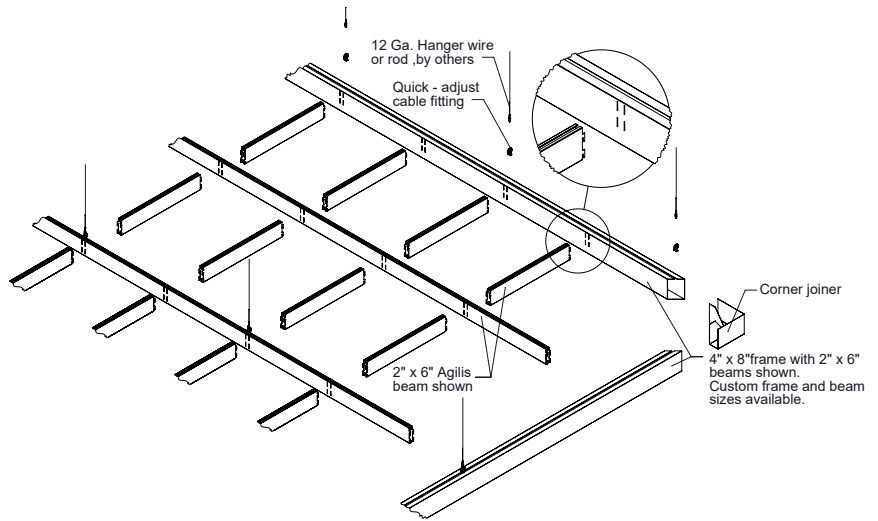

PHYSICAL DATA

- Material substrate - Aluminum | Fabricated
- Thickness .041" - .060" design dependent
- Fire Performance - Class A: Tested per ASTM E84. Flame Spread Index 25 or less. Smoke Developed Index 50 or less. CAN/ULC S102 surface burning characteristics. Flame Spread Rating 25 or less. Smoke Developed Classification 50 or less.
- Weight - Varies from .67 - 1.10 lbs./ln.ft.
- Warranty - One Year Limited
- Surface Finish - Factory-applied polyester paint. Available in Standard Colors, Color Matched and Wood Look Powder-Coated
- Seismic areas - Agilis has been engineered for use in all seismic areas. Installations may require additional attachment from baffle to suspension bar. Check with local code officials or a licensed engineer for additional requirements.
- Acoustical Options - Perforated panels are supplied with acoustic infills to absorb sound - NRC values include .60, .70, .90, .95, 1.0, 1.1

SUSTAINABILITY

CONTRIBUTES TO LEED® POINTS -

- LEED BD+C: New Construction v4
 - ▶ MR: Regional Materials
 - ▶ MR: Recycled Content
- LEED BD+C: Schools v4
 - ▶ EQ: Acoustic Performance
- LEED ID+C: Commercial Interiors v4
 - ▶ EQ: Low-Emitting Material
- No VOC'S: No added urea-formaldehyde
- FSC chain of custody veneers available
- Recycled Content - up to 85%

LEED® is a registered trademark of the U.S. Green Building Council

FEATURES

- Create on trend linear designs
- Unlimited finish options - custom colors, wood looks, films & wood veneers
- 16 standard wood look finishes
- Custom sizes & shapes - At Maxxit custom is what we do best. We will make any shape or size you can design.
- Standard sizes - in addition to custom we also have quick ship standard products available made to order
 - ▶ Lengths - up to 12'
 - ▶ Depths - up to 15"
 - ▶ Widths - up to 24"
- Quick ship and expedited shipping
- Available in acoustic perforated styles
- Lightweight, pre-assembled & easy to install
- Versatile attachment options for Unistrut® 15/16" HD Grid and Cable hung applications
- Cleanable using CDC recommended and EPA-approved disinfectants for fog, spray & wipe
- Integrated lighting options available

WOOD LOOK FINISHES

Standard Powder Coated Paint Finishes (Interior & Exterior) Formaldehyde-Free



Custom Colors

FIND YOUR PERFECT MATCH

At Maxxit we have a passion for finishes; wood, metallic, oil rubbed, whatever your challenge is we can match it!



Send us a color sample so we can quickly provide a color match.

Standard Laminated (Film) Finishes (interior only). Formaldehyde-free



COLOR & FINISHES

Maxxit powder coat finishes offer superior chemical, scratch and UV resistance, they do not emit VOC's and are available in a broad range of textures, glosses and specialty looks.

Standard Colors

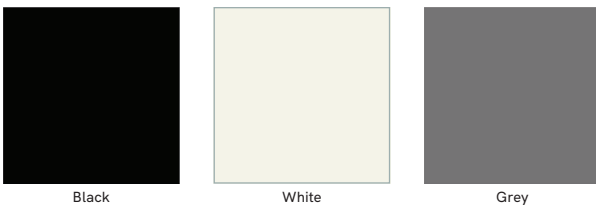

Black Finishes

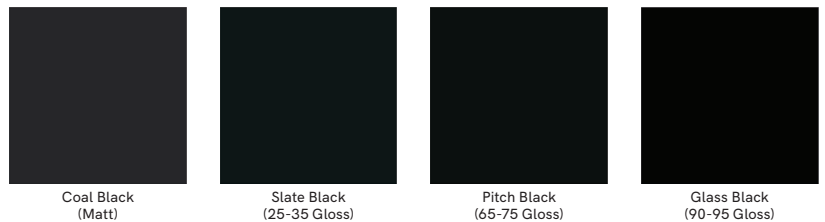

White Finishes

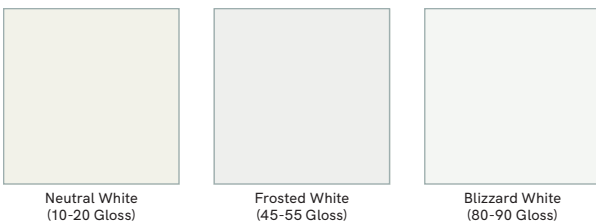

Custom Colors

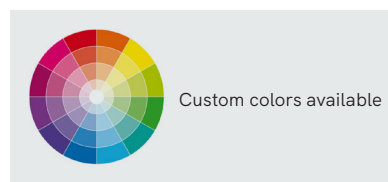

PERFORATIONS

Perforation Options (Additional perforations available upon request.)



Unperforated

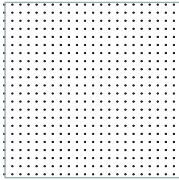

#2 Straight
Open area 2%
Centers 0.1968"
Diameter 0.032"

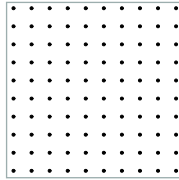

#3 Straight
Open area 2.10%
Centers 0.3788"
Diameter 0.0625"

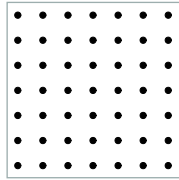

#4 Straight
Open area 4.90%
Centers 0.5"
Diameter 0.125"

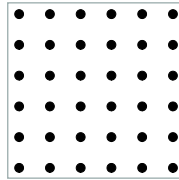

#6 Straight
Open area 6.50%
Centers 0.5412"
Diameter 0.1562"

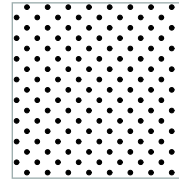

#8 Staggered
Open area 8.0%
Centers 0.306"
Diameter 0.098"

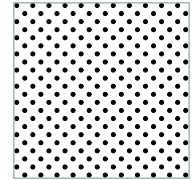

#9 Staggered
Open area 9.80%
Centers 0.3536"
Diameter 0.125"

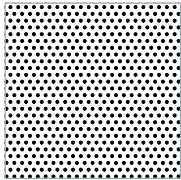

#12 Staggered
Open area 13.40%
Centers 0.1624"
Diameter 0.0625"

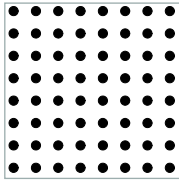

#13 Straight
Open area 13.40%
Centers 0.3789"
Diameter 0.1562"

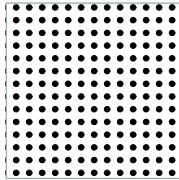

#14 Straight
Open area 14.70%
Centers 0.2706"
Diameter 0.117"

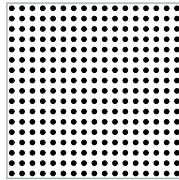

#16 Straight
Open area 16.0%
Centers 0.216"
Diameter 0.098"

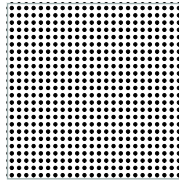

#17 Straight
Open area 17.10%
Centers 0.2012"
Diameter 0.0938"

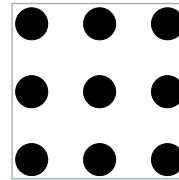

#18 Straight
Open area 17.50%
Centers 1.1908"
Diameter 0.5652"

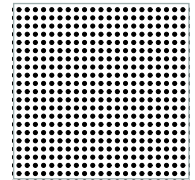

#19 Straight
Open area 19.60%
Centers 0.25"
Diameter 0.125"

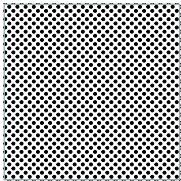

#20 Staggered
Open area 20%
Centers 0.197"
Diameter 0.071"

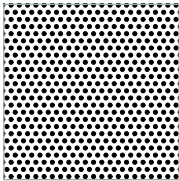

#22 Staggered
Open area 22.70%
Centers 0.25"
Diameter 0.125"

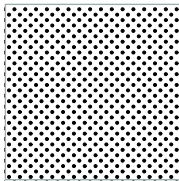

#23 Staggered
Open area 23.0%
Centers 0.160"
Diameter 0.063"

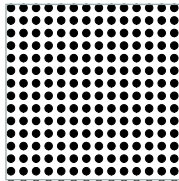

#29 Straight
Open area 29.50%
Centers 0.256"
Diameter 0.157"



AGILIS DESIGNS

ELEVATIONS ▾



SHUFFLE ▾



NETWORKS ▾



ANGLE ▲



PANELS ▲



TRADITIONAL ▲

DESIGN REALIZED

From the familiar to the truly one of a kind, Maxxit brings your design vision to life. With ceilings and walls crafted from Wood, Felt, Metal, Composites & more there is no limit to what we can create together.

