

Agilis Elevations delivers bold texture and directional flow in a design that can be scaled for small, medium and large spaces.

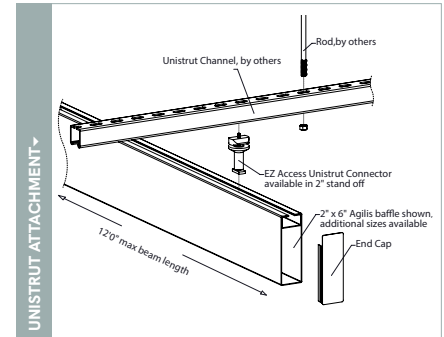
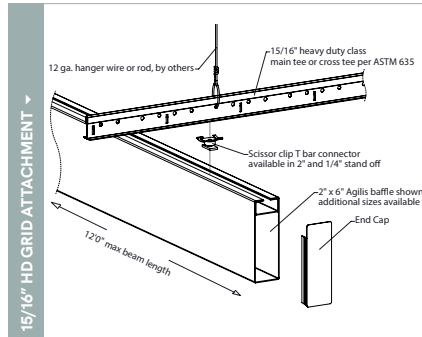
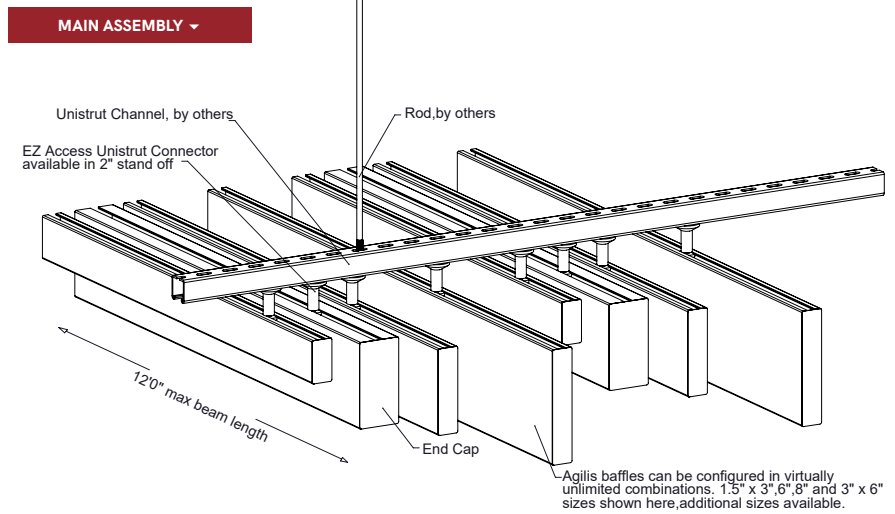

PHYSICAL DATA

- Material substrate - Aluminum | Fabricated
- Thickness .041" - .060" design dependent
- Fire Performance - Class A: Tested per ASTM E84. Flame Spread Index 25 or less. Smoke Developed Index 50 or less. CAN/ULC S102 surface burning characteristics. Flame Spread Rating 25 or less. Smoke Developed Classification 50 or less.
- Weight - Varies from .67 - 1.10 lbs./ln.ft.
- Warranty - One Year Limited
- Surface Finish - Factory-applied polyester paint. Available in Standard Colors, Color Matched and Wood Look Powder-Coated
- Seismic areas - Agilis has been engineered for use in all seismic areas. Installations may require additional attachment from baffle to suspension bar. Check with local code officials or a licensed engineer for additional requirements.
- Acoustical Options - Perforated panels are supplied with acoustic infills to absorb sound - NRC values include .60, .70, .90, .95, 1.0, 1.1

SUSTAINABILITY

CONTRIBUTES TO LEED® POINTS -

- LEED BD+C: New Construction v4
 - ▶ MR: Regional Materials
 - ▶ MR: Recycled Content
- LEED BD+C: Schools v4
 - ▶ EQ: Acoustic Performance
- LEED ID+C: Commercial Interiors v4
 - ▶ EQ: Low-Emitting Material

- No VOC'S: No added urea-formaldehyde
- EPD 'Environmental Product Declaration' for raw material components
- Recycled Content - up to 80%

LEED® is a registered trademark of the U.S. Green Building Council

FEATURES

- Create on trend linear designs
- Unlimited finish options - custom colors, wood looks, films & wood veneers
- 17 standard wood look finishes
- Custom sizes & shapes - At Maxxit custom is what we do best. We will make any shape or size you can design.
- Standard sizes - in addition to custom we also have quick ship standard products available made to order
 - ▶ Lengths - up to 12'
 - ▶ Depths - up to 15"
 - ▶ Widths - up to 24"
- Quick ship and expedited shipping
- Available in acoustic perforated styles
- Lightweight, pre-assembled & easy to install
- Versatile attachment options for Unistrut® 15/16" HD Grid and Cable hung applications
- Easy plenum access - attachment hardware allows baffles to slide for easy plenum access and adjustment during installation
- Cleanable using CDC recommended and EPA-approved disinfectants for fog, spray & wipe
- Integrated lighting options available

WOOD LOOK FINISHES

Standard Powder Coated Paint Finishes (Interior & Exterior) Formaldehyde-Free



Custom Colors

FIND YOUR PERFECT MATCH

At Maxxit we have a passion for finishes; wood, metallic, oil rubbed, whatever your challenge is we can match it!



Send us a color sample so we can quickly provide a color match.

Standard Laminated (Film) Finishes (interior only). Formaldehyde-free



STANDARD COLORS

Maxxit powder coat finishes offer superior chemical, scratch and UV resistance, they do not emit VOC's and are available in a broad range of textures, glosses and specialty looks.

Powder Coated Paint Finishes (Interior & Exterior) Formaldehyde-Free

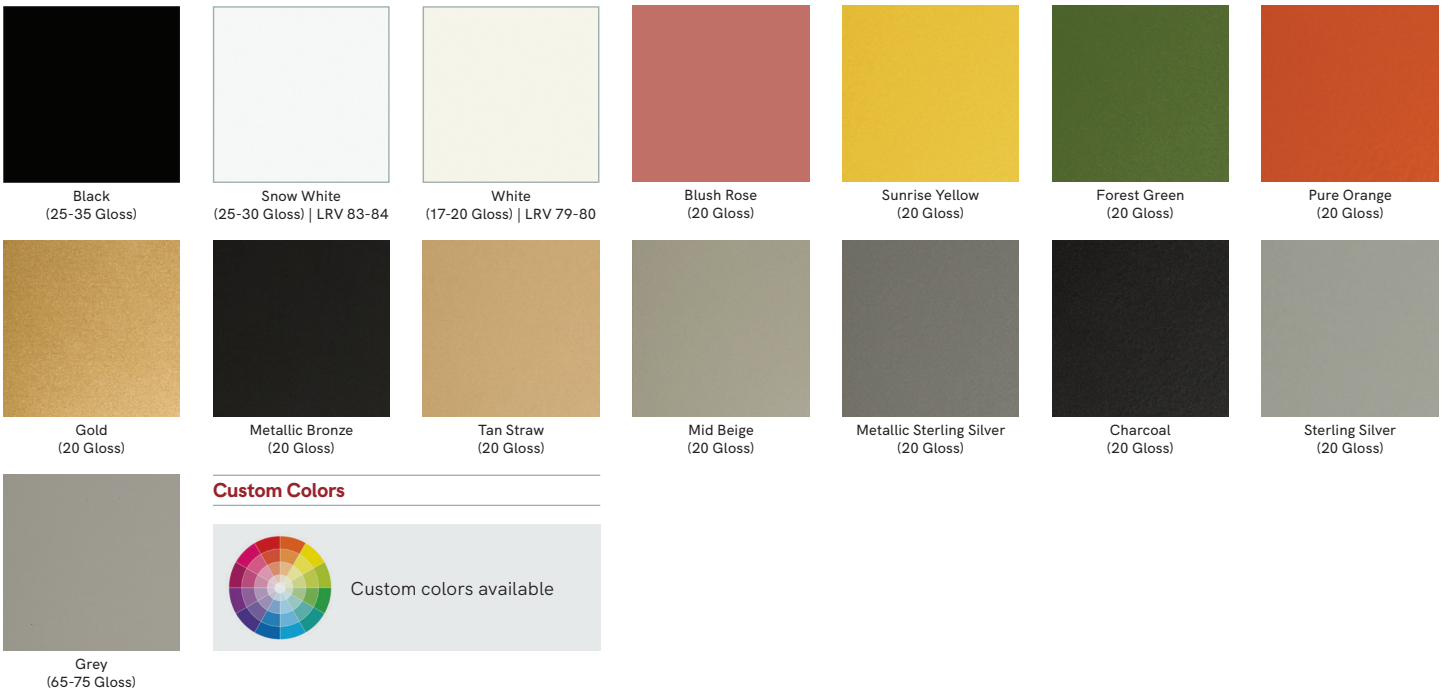

PERFORATIONS

Standard Perforations Angles - Staggered 60°

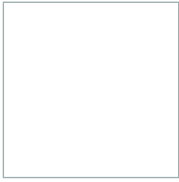

Unperforated

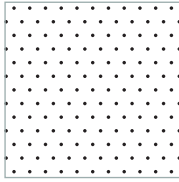

S02 Staggered
Diameter 0.0625"
Open area 4.50%
Centers 0.2812"

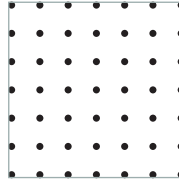

S03 Straight
Diameter 0.125"
Open area 4.90%
Centers 0.5"

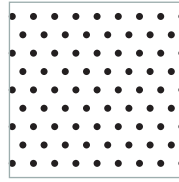

S04 Staggered
Diameter 0.125"
Open area 9.90%
Centers 0.3788"

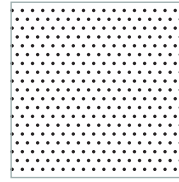

S05 Staggered
Diameter 0.0625"
Open area 10.10%
Centers 0.1875"

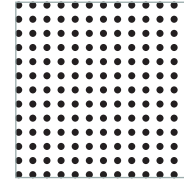

S06 Straight
Diameter 0.125"
Open area 19.60%
Centers 0.25"

Premium Perforations Angles - Diagonal 45° | Staggered 60°

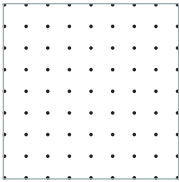

P11 Straight
Diameter 0.0625"
Open area 2.10%
Centers 0.3788"

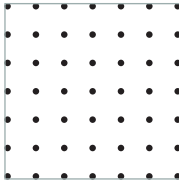

P12 Straight
Diameter 0.098"
Open area 4.14%
Centers 0.427"

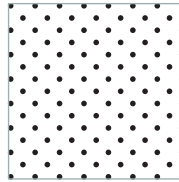

P13 Diagonal
Diameter 0.098"
Open area 8.28%
Centers 0.3019"

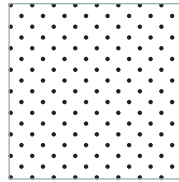

P14 Diagonal
Diameter 0.078"
Open area 26.53%
Centers 0.1898"

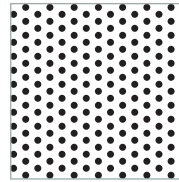

P18 Staggered
Diameter 0.125"
Open area 22.70%
Centers 0.25"

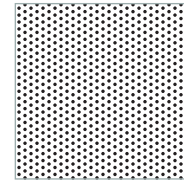

P19 Staggered
Diameter 0.0625"
Open area 22.70%
Centers 0.125"

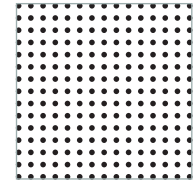

P21 Straight
Diameter 0.098"
Open area 16.55%
Centers 0.2135"





AGILIS DESIGNS

ELEVATIONS ▾



SHUFFLE ▾



NETWORKS ▾



ANGLE ▲



PANELS ▲



TRADITIONAL ▲

DESIGN REALIZED

From the familiar to the truly one of a kind, Maxxit brings your design vision to life. With ceilings and walls crafted from Wood, Felt, Metal, Composites & more there is no limit to what we can create together.

