

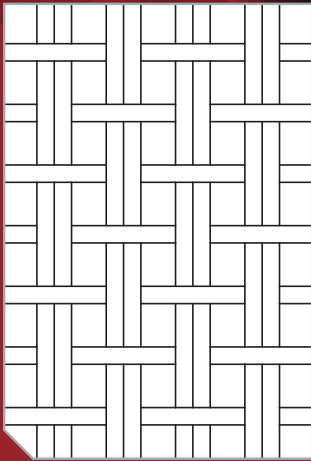

# MOZAIX™ | DOUBLE WEAVE



## Introducing next-generation ceiling designs

that break free from the conventional grid. Easily accessible from below for hassle-free plenum access, Mozaix™ designs offer 8 patterns, unlimited colors, and integrated lighting options.

Mozaix™ revolutionizes traditional full-coverage panel ceilings by eliminating grid-based constraints, allowing for diverse, non-uniform designs. With Mozaix™, you have the freedom to create unique ceiling layouts using various panel shapes, sizes, colors, and perforation patterns in unconventional orientations and depths.

Mozaix™ offers an affordable custom design upgrade by utilizing industry standard T-bar suspension systems for panel installation. This innovative approach not only provides potential retrofit cost savings but also contributes to sustainability efforts by minimizing environmental impact while maximizing aesthetic appeal.

Mozaix™ Double Weave design features an intricate pattern that intertwines layers of colors or textures, creating a dynamic visual effect reminiscent of woven fabric. This design can be tailored to suit various aesthetics, from contemporary and minimalist to traditional and rustic, making it a versatile choice for interior design projects.

## KEY FEATURES

- Easy installation and plenum access. Downward accessible.
- Utilizes typical T-bar grid (new or existing). Sustainable and economical.
- Ceiling design re-imagined. Create unique ceiling designs from a collage of panel shapes, sizes and colors, in non-traditional orientations and depths.
- Integrated options - Lighting, HVAC, Sprinklers.
- Reduces noise and enhances acoustics (with perforations and infill).

**WOOD STANDARD POWDER COATED PAINT FINISHES** (Interior & Exterior) Formaldehyde-Free



**CUSTOM COLOR**

**FIND YOUR PERFECT MATCH**

At Maxxit we have a passion for finishes; wood, metallic, oil rubbed, whatever your challenge is we can match it!



Send us a color sample so we can quickly provide a color match.

**WOOD STANDARD LAMINATED (FILM) FINISHES** (Interior only). Formaldehyde-free



**COLORS POWDER COATED PAINT FINISHES** (Interior & Exterior) Formaldehyde-Free



**CUSTOM COLOR**

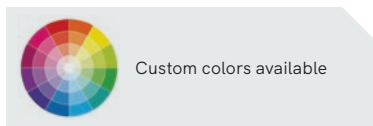

**STANDARD PERFORATIONS** Angles - Staggered 60°

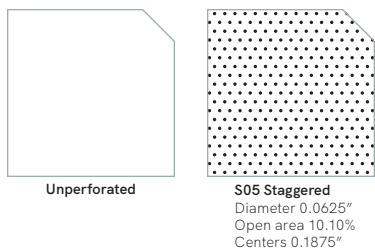

Unperforated

S05 Staggered  
Diameter 0.0625"  
Open area 10.10%  
Centers 0.1875"

CONCEPT & INSTALLATION

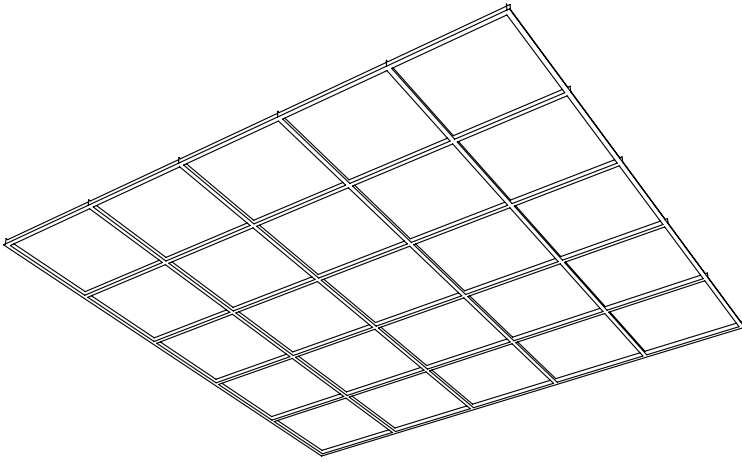

**1** EXISTING T-BAR CEILING

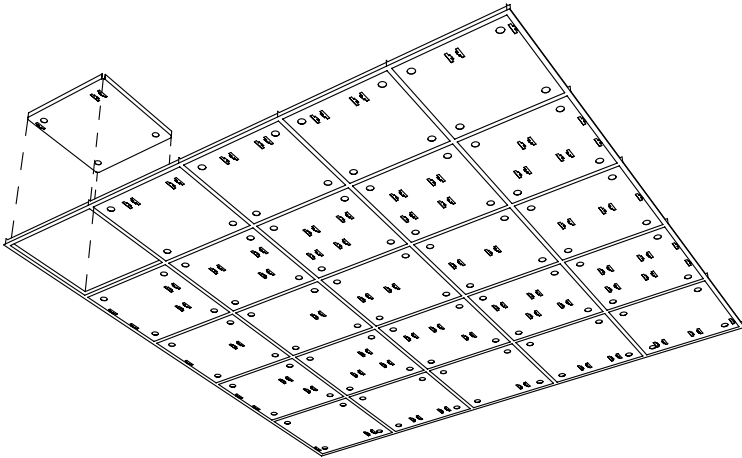

**2** LAY IN SUSPENSION PANELS

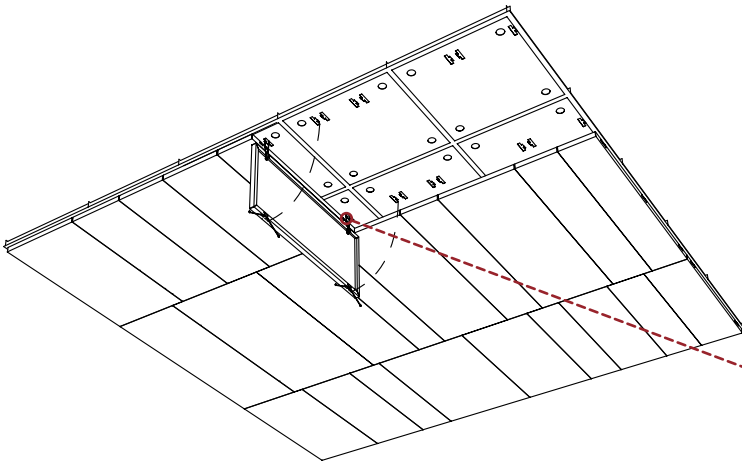

**3** MOUNT DECORATIVE PANELS

■ Torsion spring

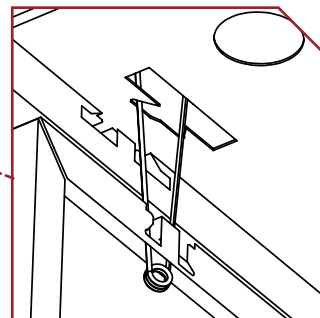

## CONFIGURATION

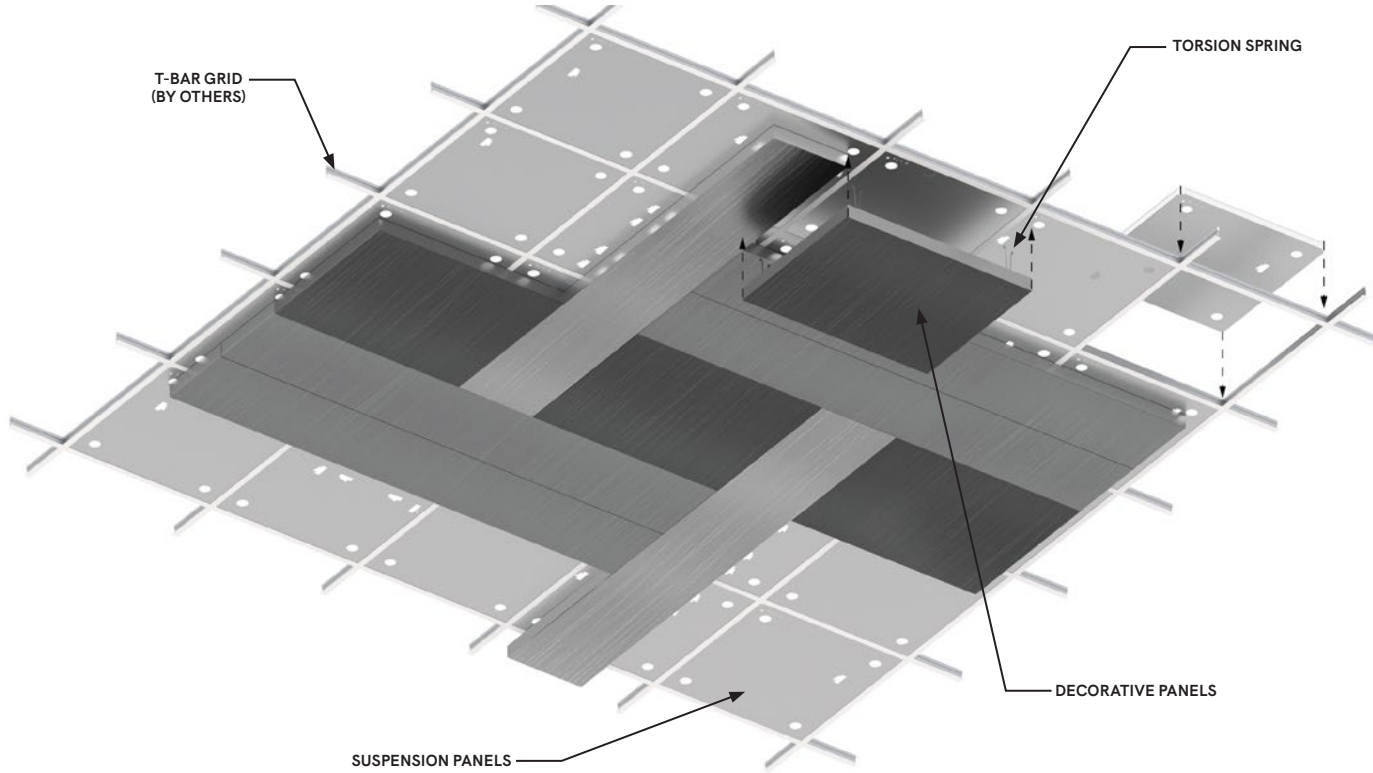

## INTEGRATION OPTIONS

### LIGHTING INTEGRATION

Optional linear accent lights can be integrated in between panels. Other integrated lighting options include flat light troffers (size restrictions apply) as well as square and round standard pot lights.

### HVAC INTEGRATION

The design is engineered to accommodate standard diffusers. This ensures seamless integration into existing architectural layouts and lighting configurations, offering versatility and ease of installation.

### SPRINKLER INTEGRATION

Sprinklers can be integrated within the panels. It is recommended to use fire suppression systems with flexible connections and concealed sprinkler heads. This integration ensures efficient and discreet fire protection throughout the space, enhancing safety measures without compromising the visual integrity of the environment.



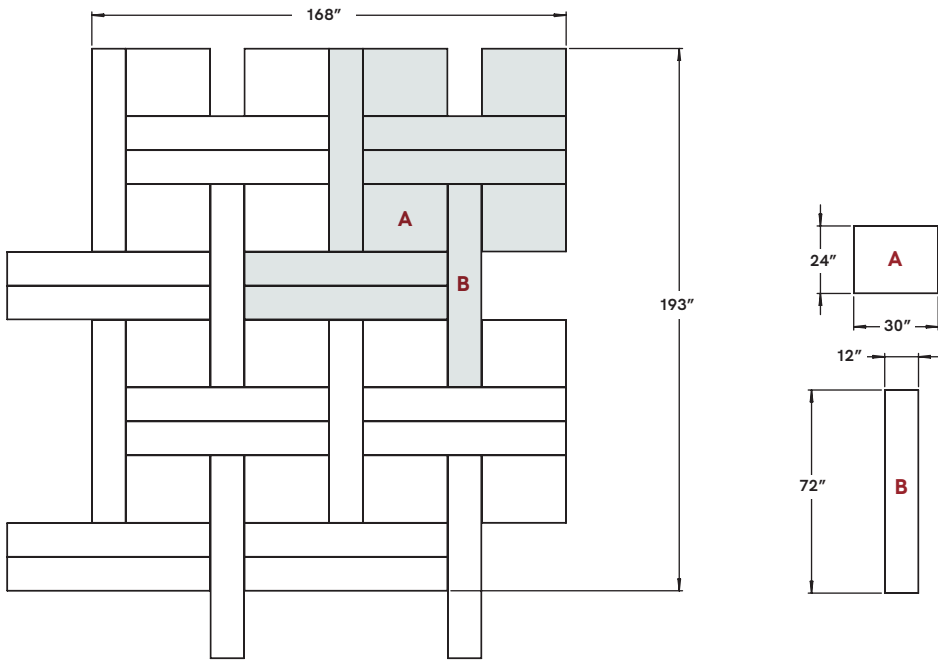



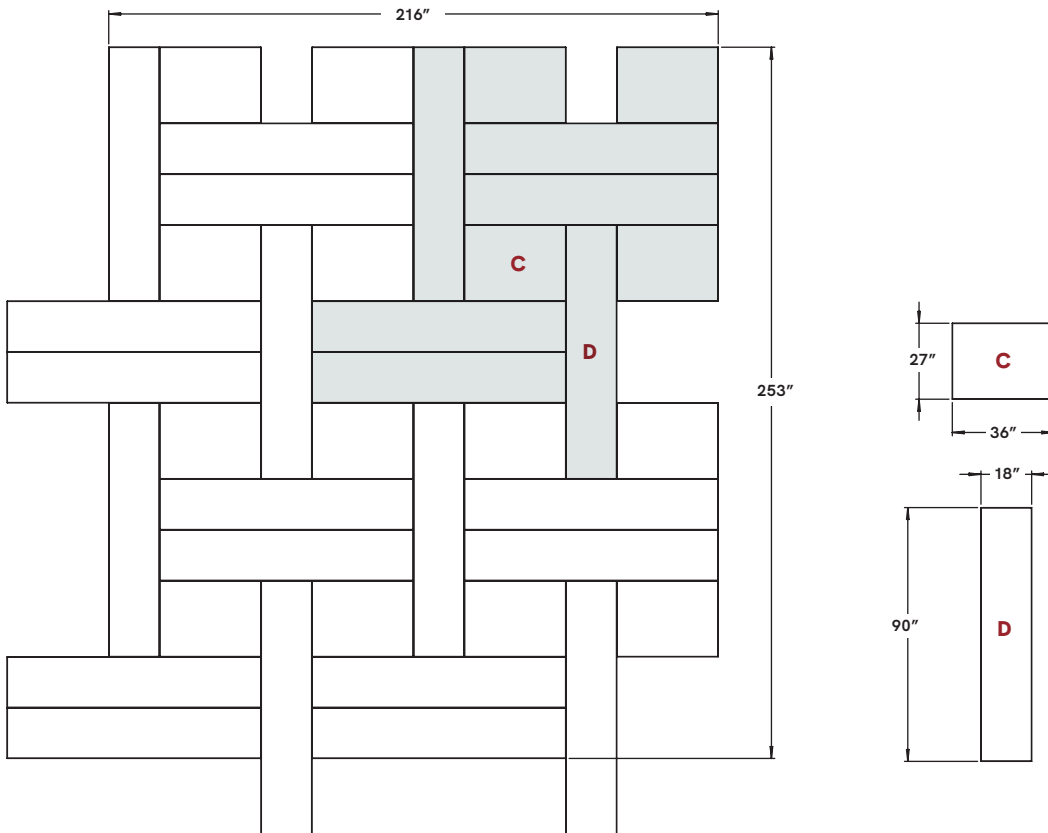







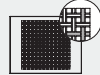

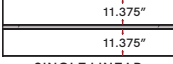

CONFIGURATION OPTIONS



All dimensions are nominal.

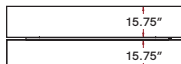

CONFIGURATION OPTIONS

INTEGRATED THIRD-PARTY SOLUTIONS						
PANEL SIZE	LINEAR LIGHT	TROFFER LIGHT	POT LIGHT	HVAC SQUARE	HVAC SURFACE MOUNT	HVAC LINEAR
<p>30" x 24"</p>  <p>A</p>		 <p>2' X 2' TROFFER</p> <p><i>*Unequal borders</i></p>	 <p>ROUND POT LIGHT SPEC SIZE AND PLACEMENT</p>  <p>SQUARE POT LIGHT SPEC SIZE AND PLACEMENT</p> <p><i>*Includes Remote T-BAR Driver Mounting Plate</i></p>	 <p>2' X 2' DIFFUSER</p>  <p>CUSTOM PERFORATION FOR RETURN AIR</p> <p><i>*Unequal borders</i></p>	 <p>SURFACE MOUNT DIFFUSER SPEC SIZE AND SHAPE</p>	
<p>72" X 12"</p>  <p>B</p>	 <p>11.375" 11.375"</p> <p>SINGLE LINEAR ACCENT LIGHT</p> <p><i>*Requires custom reduced width panel.</i></p>	<p><i>*Requires custom reduced width panel.</i></p>				 <p>1 SLOT LINEAR DIFFUSER MAX LENGTH SHOWN</p>  <p>5 SLOT LINEAR DIFFUSER MAX LENGTH SHOWN</p> <p><i>*For use with black linear diffusers. Confirm specific models with Maxxit at time of order.</i></p>
<p>36" x 27"</p>  <p>C</p>		 <p>2' X 2' TROFFER</p> <p><i>*Unequal borders</i></p>	 <p>ROUND POT LIGHT SPEC SIZE AND PLACEMENT</p>  <p>SQUARE POT LIGHT SPEC SIZE AND PLACEMENT</p> <p><i>*Includes Remote T-BAR Driver Mounting Plate</i></p>	 <p>2' X 2' DIFFUSER</p>  <p>CUSTOM PERFORATION FOR RETURN AIR</p> <p><i>*Unequal borders</i></p>	 <p>SURFACE MOUNT DIFFUSER SPEC SIZE AND SHAPE</p>	
<p>90" X 18"</p>  <p>D</p>	 <p>15.75" 15.75"</p> <p>SINGLE LINEAR ACCENT LIGHT</p> <p><i>*Requires custom reduced width panel.</i></p>					 <p>1 SLOT LINEAR DIFFUSER MAX LENGTH SHOWN</p>  <p>5 SLOT LINEAR DIFFUSER MAX LENGTH SHOWN</p> <p><i>*For use with black linear diffusers. Confirm specific models with Maxxit at time of order.</i></p>

SPRINKLER INTEGRATION IS AVAILABLE ON ALL PANEL SIZES



ACOUSTICAL PERFORMANCE					
PERFORATION PATTERN	OPEN AREA	DIAMETER	CENTERS	ACOUSTIC INFILL	NRC
S05 STAGGERED	10.10%	0.0625"	0.1875"	Acoustic Non-Woven	0.75
				1" Surface Coated Fiberglass	0.80
				Acoustic Non-Woven & 1" Surface Coated Fiberglass	0.90

Sound Absorption and Sound Absorption Coefficients by the Reverberation Room Method ASTM C423, E-400-Mount. Mozaix panels are fully perforated across the entire surface - no unperforated edges.

Choose from three levels of acoustic comfort — Good, Better, and Best — tailored to meet your unique sound control needs.

**ACOUSTIC NON-WOVEN** - At only 0.01" thickness, acoustic nonwoven offers high degree of sound absorption. Available in white and black. Fire rated Class A - FSI 0 SDI 35; ASTM E84-19a.

**1" SURFACE COATED FIBERGLASS** - Greenguard certified, made from strong, glass fibers tightly bonded and protected with a durable glass mat facing that contains an EPA-registered antimicrobial agent; no polywrapping required. Offered in Black. Greenguard Gold version available. Fire rate Class A - FSI 25 SDI 50 ; ASTM E84-19a, CAN/ULC S102.



**FEATURES**

- Creates a distinctive double weave pattern by incorporating various combinations of rectangular shapes in different sizes
- Unlimited finish options - standard and custom solid and wood look colors
- Standard sizes (Double Weave) - See Configuration Options for available size combinations
- Depth up to 3" (1.5" standard)
- Lightweight and easy to install
- Supported by traditional 15/16" HD Grid system
- Integrated Lighting, HVAC and Sprinkler options available.
- Torsion spring design allows for easy downward access panel removal
- Suspension Panels drop into the grid and don't require any fasteners
- Mozaix panels feature a fully perforated design that extends seamlessly across the entire surface, delivering a sleek, uniform look with no unperforated edges.

**PHYSICAL DATA**

- Material substrate - Aluminum (Decorative Panels), Galvanized Steel (Suspension Panels)
- Thickness .041" - .060" design dependent
- Fire Performance - Class A: Tested per ASTM E84, CAN/ULC S102 surface burning characteristics
- Weight - Varies from .67 - 1.10 lbs./sq.ft.
- Warranty - One Year Limited
- Surface Finish - Factory-applied polyester paint. Available in Standard Colors, Color Matched, Wood Look Powder-Coated and Laminated.
- Seismic areas - Mozaix™ has been engineered for use in all seismic areas. Check with local code officials or a licensed engineer for additional requirements.
- Acoustical Options - Perforated panels are supplied with optional acoustic infills to absorb sound

**SUSTAINABILITY**

**CONTRIBUTES TO LEED® POINTS -**

- LEED BD+C: New Construction v4
  - ▶ MR: Regional Materials
  - ▶ MR: Recycled Content
- LEED BD+C: Schools v4
  - ▶ EQ: Acoustic Performance
- LEED ID+C: Commercial Interiors v4
  - ▶ EQ: Low-Emitting Materials

- No VOC'S: No added urea-formaldehyde
- EPD 'Environmental Product Declaration' for raw material components
- Recycled Content - up to 80%

LEED® is a registered trademark of the U.S. Green Building Council

Mozaix™ standard design range presents a variety of well-known popular shapes and patterns that enhance the intrigue and depth of ceiling architecture.

## STANDARD PATTERNS

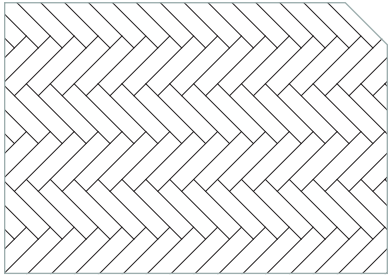

Herringbone

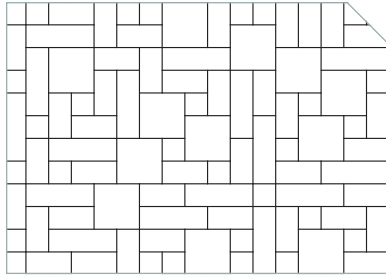

Interlock

Inspired by familiar flooring designs, the Herringbone pattern exudes a timeless elegance, providing both consistency and repetition to the surface. In contrast, Interlock introduces an element of unpredictability and complexity.

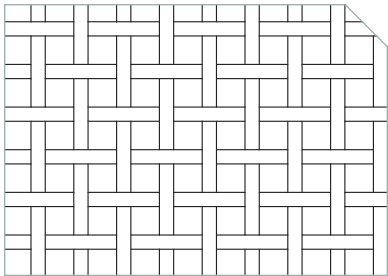

Weave

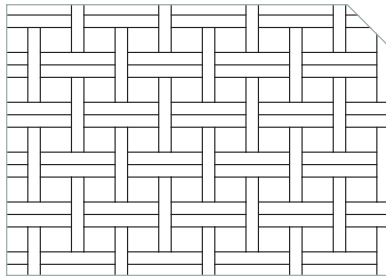

Double Weave

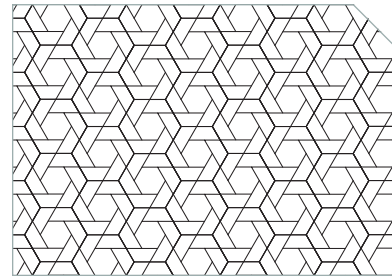

Hex Weave

Weave and Double Weave offer an interlacing effect that suggests interconnectedness, adding depth to the design. Hex Weave provides a bold departure from expected geometry, opening doors to innovative and dramatic effects.

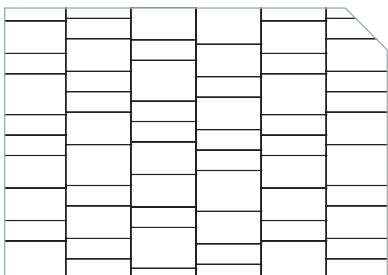

Stacked

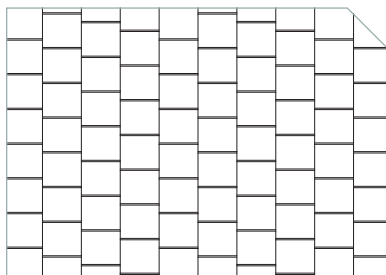

Shift

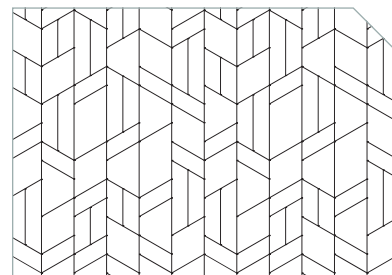

Arrow

Stacked formation deviates from the uniformity of traditional panel designs. Staggered, offset nature of Shift pattern adds unique rhythm and style while celebrating the intricacy of the in-between seams. Arrow symbolizes direction and introduces dynamic movement to any space.



## PANELS



## LINEAR



## OPEN CELL



Mozaix™ is patent pending.



# NOTHING IS IMPOSSIBLE

Maxxit helps architects and interior designers realize their design intent with creative engineering solutions, a broad range of manufacturing capabilities and unlimited finishing options. From the familiar to the truly one of a kind, Maxxit brings your design vision to life.

Our engineers are masters of metals, wood, felt, glass, composites and more, working in a single medium or combining them in unexpected ways to create stunning architectural solutions. There is no limit to what we can create together.

[MAXXITGROUP.COM/MOZAIX](http://MAXXITGROUP.COM/MOZAIX)

MAXXIT