

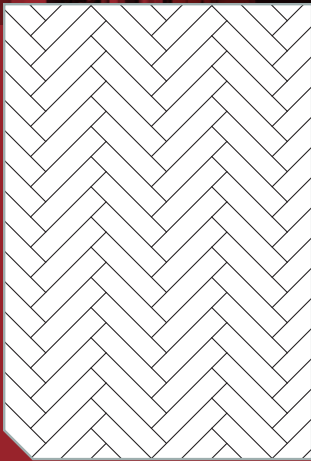

MOZAIX™

HERRINGBONE

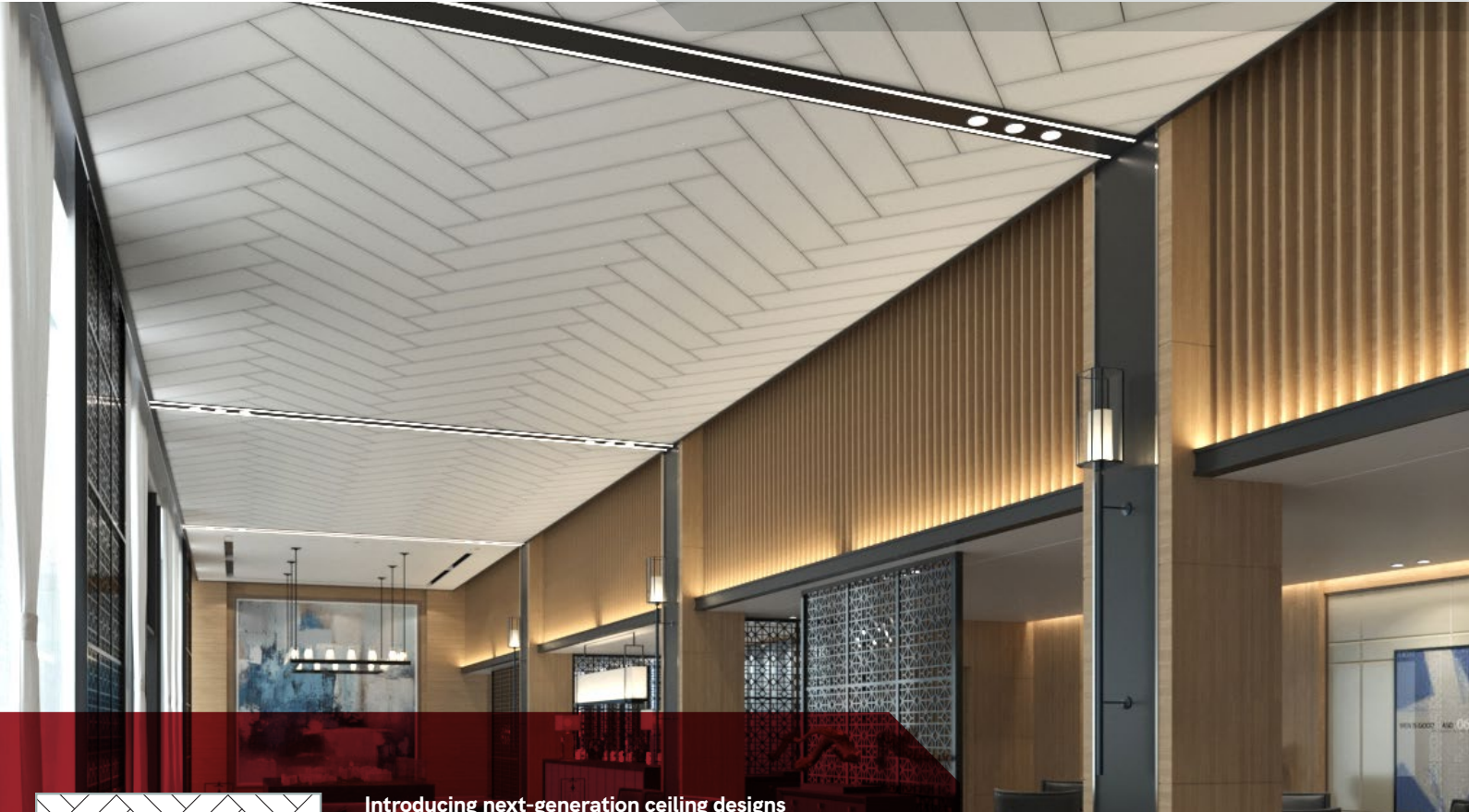

Introducing next-generation ceiling designs

that break free from the conventional grid. Easily accessible from below for hassle-free plenum access, Mozaix™ designs offer 8 patterns, unlimited colors, and integrated lighting options.

Mozaix™ revolutionizes traditional full-coverage panel ceilings by eliminating grid-based constraints, allowing for diverse, non-uniform designs. With Mozaix™, you have the freedom to create unique ceiling layouts using various panel shapes, sizes, colors, and perforation patterns in unconventional orientations and depths.

Mozaix™ offers an affordable custom design upgrade by utilizing industry standard T-bar suspension systems for panel installation. This innovative approach not only provides potential retrofit cost savings but also contributes to sustainability efforts by minimizing environmental impact while maximizing aesthetic appeal.

Mozaix™ Herringbone design exudes a timeless elegance, providing both consistency and repetition to the ceiling surface. Its distinctive V-shaped arrangement offers a sophisticated look that enhances any interior space. This classic pattern is perfect for creating a sense of order and refinement, making it a favorite choice for both traditional and contemporary designs.

KEY FEATURES

- Easy installation and plenum access. Downward accessible.
- Utilizes typical T-bar grid (new or existing). Sustainable and economical.
- Ceiling design re-imagined. Create unique ceiling designs from a collage of panel shapes, sizes and colors, in non-traditional orientations and depths.
- Integrated options - Lighting, HVAC, Sprinklers.
- Reduces noise and enhances acoustics.

WOOD STANDARD POWDER COATED PAINT FINISHES (Interior & Exterior) Formaldehyde-Free



CUSTOM COLOR

FIND YOUR PERFECT MATCH

At Maxxit we have a passion for finishes; wood, metallic, oil rubbed, whatever your challenge is we can match it!

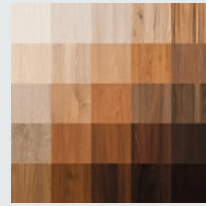

Send us a color sample so we can quickly provide a color match.

WOOD STANDARD LAMINATED (FILM) FINISHES (Interior only). Formaldehyde-free



COLORS POWDER COATED PAINT FINISHES (Interior & Exterior) Formaldehyde-Free



STANDARD PERFORATIONS Angles - Staggered 60°

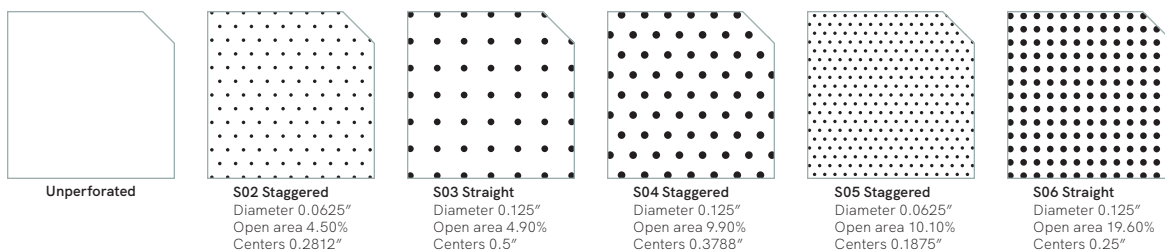

CONCEPT & INSTALLATION

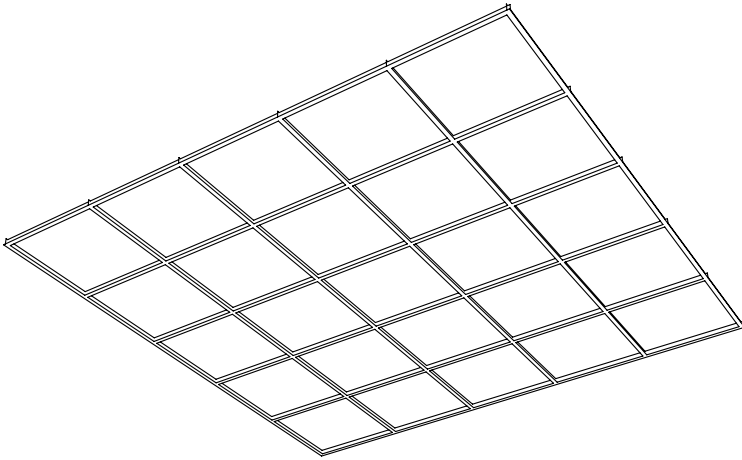

1 EXISTING T-BAR CEILING

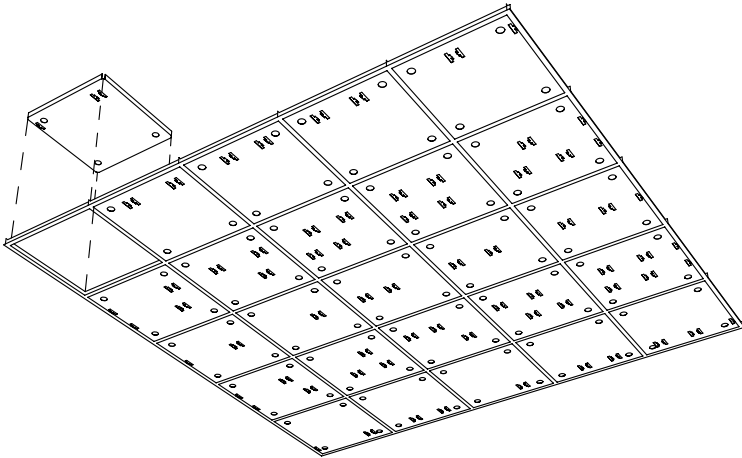

2 LAY IN SUSPENSION PANELS

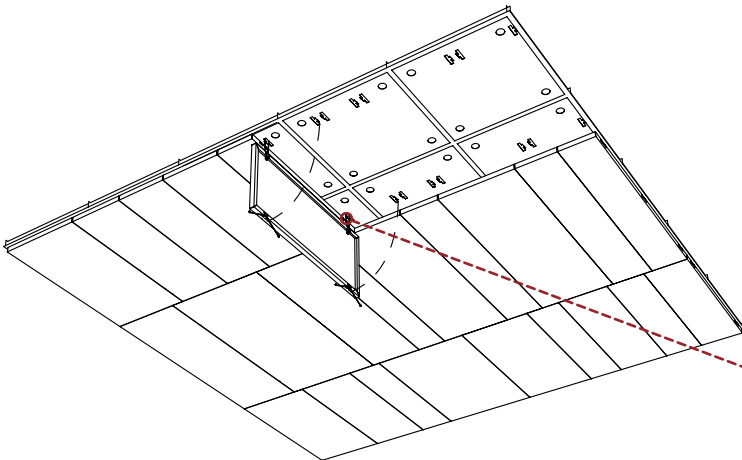

3 MOUNT DECORATIVE PANELS

■ Torsion spring

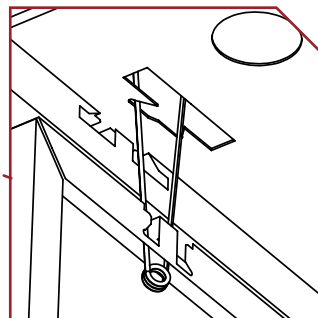

CONFIGURATION

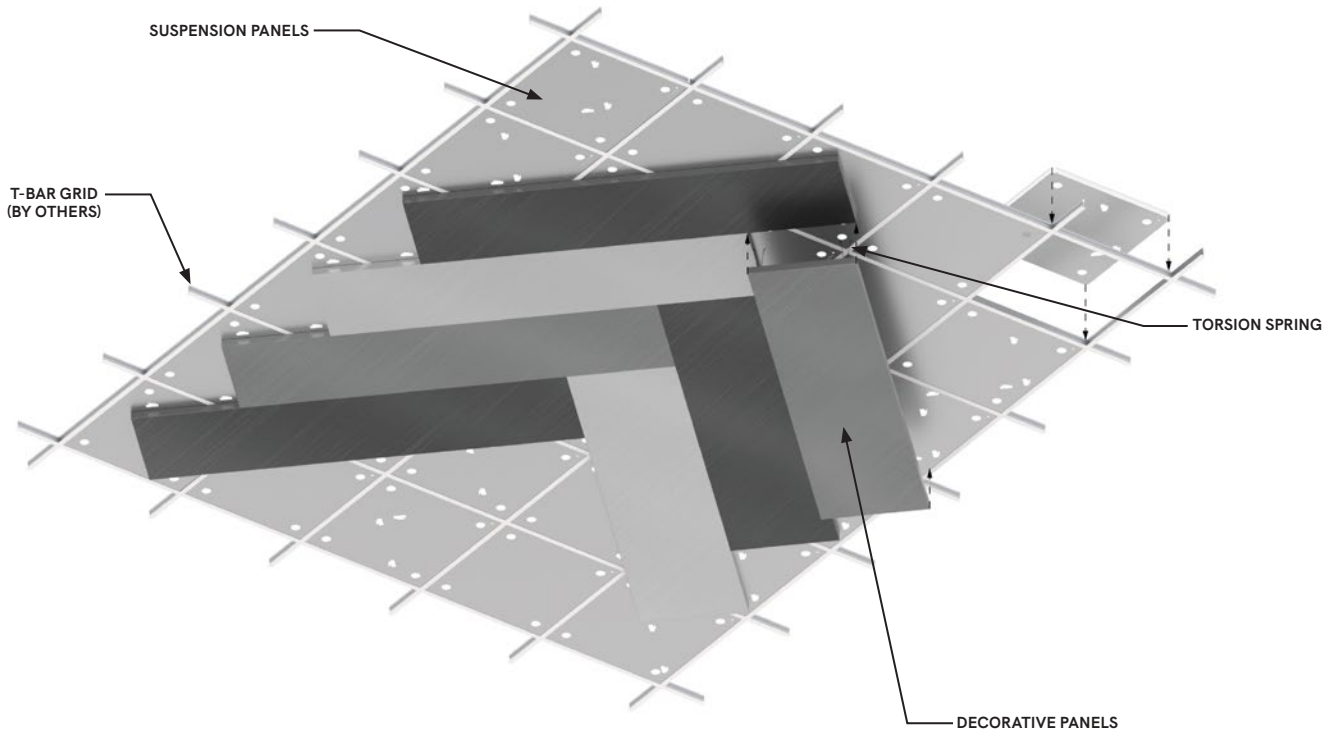

INTEGRATION OPTIONS

LIGHTING INTEGRATION

Optional 1" Mozaix linear accent lights can be integrated in between panels. Other integrated lighting options include flat light troffers (size restrictions apply) as well as square and round standard pot lights.

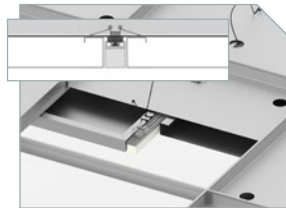

LINEAR LIGHT

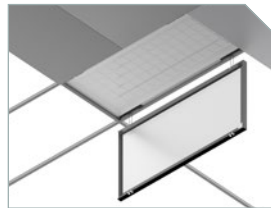

TROFFER LIGHT

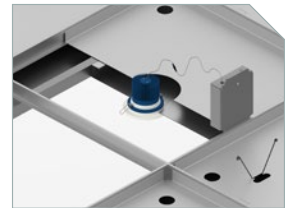

POT LIGHT

HVAC INTEGRATION

The design is engineered to accommodate standard diffusers. This ensures seamless integration into existing architectural layouts and lighting configurations, offering versatility and ease of installation.

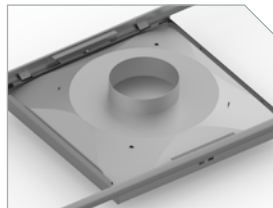

SQUARE DIFFUSER

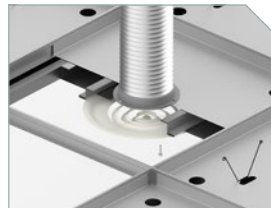

SURFACE MOUNT DIFFUSER

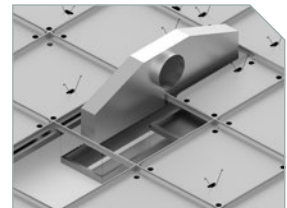

LINEAR DIFFUSER

SPRINKLER INTEGRATION

Sprinklers can be integrated within the panels. It is recommended to use fire suppression systems with flexible connections and concealed sprinkler heads. This integration ensures efficient and discreet fire protection throughout the space, enhancing safety measures without compromising the visual integrity of the environment.

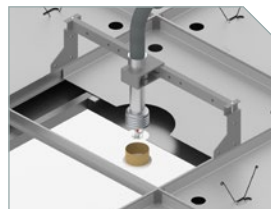





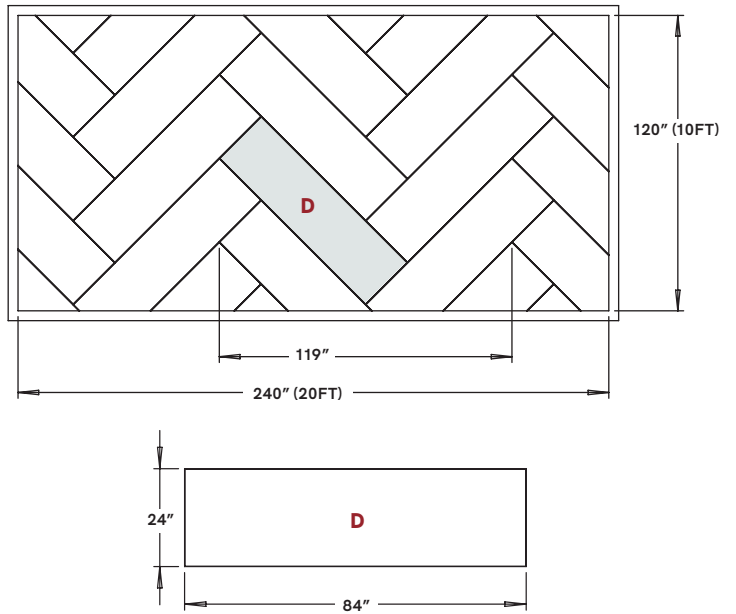
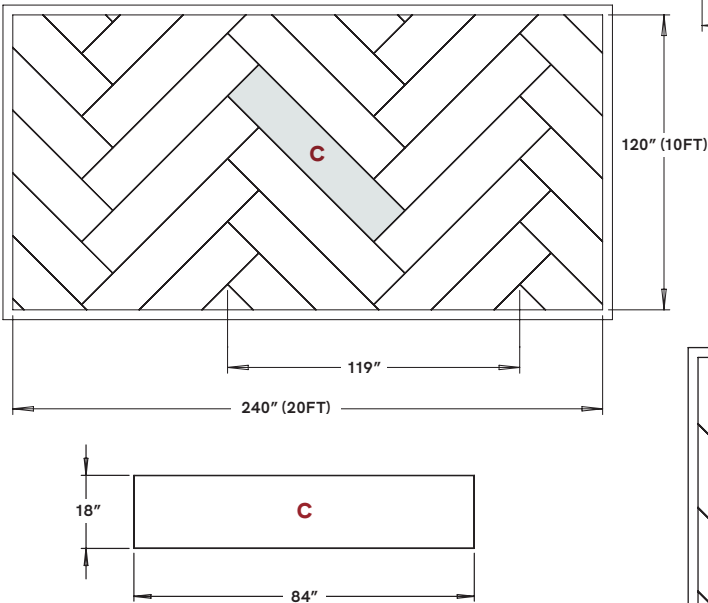
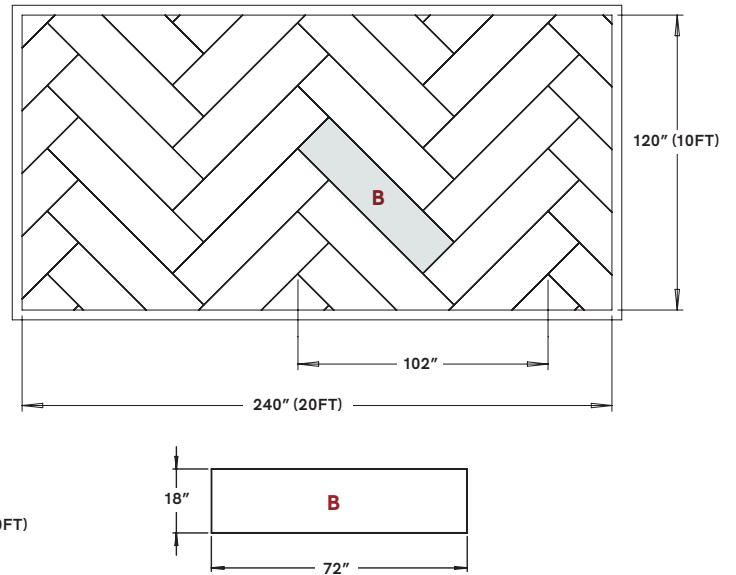
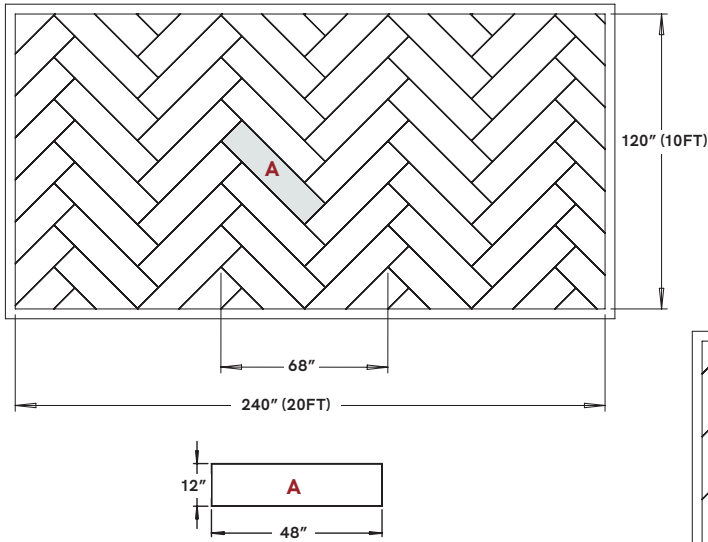





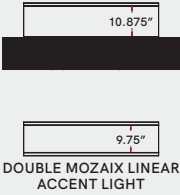

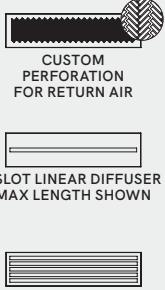
SPRINKLER

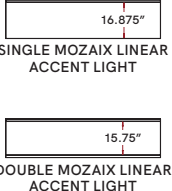
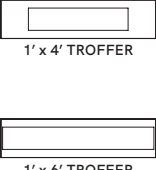
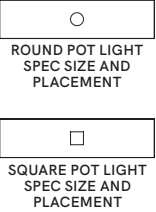
CONFIGURATION OPTIONS

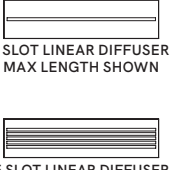

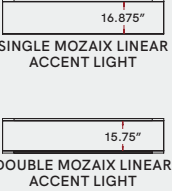
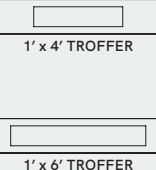
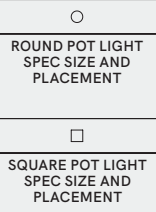
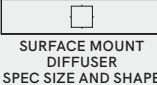
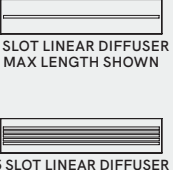
All dimensions are nominal.

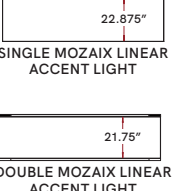
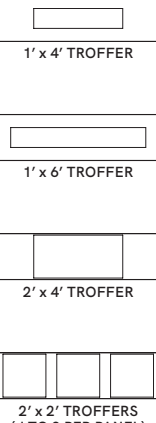
CONFIGURATION OPTIONS

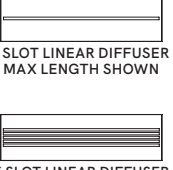
INTEGRATED THIRD-PARTY SOLUTIONS						
PANEL SIZE	LINEAR LIGHT	TROFFER LIGHT	POT LIGHT	HVAC SQUARE	HVAC SURFACE MOUNT	HVAC LINEAR
<p>12" x 48"</p>  <p>A</p>	 <p>10.875"</p> <p>9.75"</p> <p>DOUBLE MOZAIX LINEAR ACCENT LIGHT</p> <p><i>*Requires custom reduced width panel.</i></p>	 <p>1' x 4' TROFFER</p>	 <p>ROUND POT LIGHT SPEC SIZE AND PLACEMENT</p> <p>SQUARE POT LIGHT SPEC SIZE AND PLACEMENT</p> <p><i>*Includes Remote T-BAR Driver Mounting Plate</i></p>			 <p>CUSTOM PERFORATION FOR RETURN AIR</p> <p>1 SLOT LINEAR DIFFUSER MAX LENGTH SHOWN</p> <p>5 SLOT LINEAR DIFFUSER MAX LENGTH SHOWN</p> <p><i>*For use with black linear diffusers. Confirm specific models with Maxxit at time of order.</i></p>
<p>18" x 72"</p>  <p>B</p>	 <p>16.875"</p> <p>15.75"</p> <p>SINGLE MOZAIX LINEAR ACCENT LIGHT</p> <p>DOUBLE MOZAIX LINEAR ACCENT LIGHT</p> <p><i>*Requires custom reduced width panel.</i></p>	 <p>1' x 4' TROFFER</p> <p>1' x 6' TROFFER</p> <p><i>*Unequal borders</i></p>	 <p>ROUND POT LIGHT SPEC SIZE AND PLACEMENT</p> <p>SQUARE POT LIGHT SPEC SIZE AND PLACEMENT</p> <p><i>*Includes Remote T-BAR Driver Mounting Plate</i></p>		 <p>SURFACE MOUNT DIFFUSER SPEC SIZE AND SHAPE</p>	 <p>1 SLOT LINEAR DIFFUSER MAX LENGTH SHOWN</p> <p>5 SLOT LINEAR DIFFUSER MAX LENGTH SHOWN</p> <p><i>*For use with black linear diffusers. Confirm specific models with Maxxit at time of order.</i></p>
<p>18" x 84"</p>  <p>C</p>	 <p>16.875"</p> <p>15.75"</p> <p>SINGLE MOZAIX LINEAR ACCENT LIGHT</p> <p>DOUBLE MOZAIX LINEAR ACCENT LIGHT</p> <p><i>*Requires custom reduced width panel.</i></p>	 <p>1' x 4' TROFFER</p> <p>1' x 6' TROFFER</p> <p><i>*Unequal borders</i></p>	 <p>ROUND POT LIGHT SPEC SIZE AND PLACEMENT</p> <p>SQUARE POT LIGHT SPEC SIZE AND PLACEMENT</p> <p><i>*Includes Remote T-BAR Driver Mounting Plate</i></p>		 <p>SURFACE MOUNT DIFFUSER SPEC SIZE AND SHAPE</p>	 <p>1 SLOT LINEAR DIFFUSER MAX LENGTH SHOWN</p> <p>5 SLOT LINEAR DIFFUSER MAX LENGTH SHOWN</p> <p><i>*For use with black linear diffusers. Confirm specific models with Maxxit at time of order.</i></p>
<p>24" x 84"</p>  <p>D</p>	 <p>22.875"</p> <p>21.75"</p> <p>SINGLE MOZAIX LINEAR ACCENT LIGHT</p> <p>DOUBLE MOZAIX LINEAR ACCENT LIGHT</p> <p><i>*Requires custom reduced width panel.</i></p>	 <p>1' x 4' TROFFER</p> <p>1' x 6' TROFFER</p> <p>2' x 4' TROFFER</p> <p>2' x 2' TROFFERS (1 TO 3 PER PANEL)</p> <p><i>*Unequal borders</i></p>		 <p>2' X 2' DIFFUSER</p> <p><i>*Unequal borders</i></p>	 <p>SURFACE MOUNT DIFFUSER SPEC SIZE AND SHAPE</p>	 <p>1 SLOT LINEAR DIFFUSER MAX LENGTH SHOWN</p> <p>5 SLOT LINEAR DIFFUSER MAX LENGTH SHOWN</p> <p><i>*For use with black linear diffusers. Confirm specific models with Maxxit at time of order.</i></p>

SPRINKLER INTEGRATION IS AVAILABLE ON ALL PANEL SIZES

ACOUSTICAL PERFORMANCE				
PERFORATION PATTERN	DIAMETER	OPEN AREA	NRC WITH ACOUSTICAL FLEECE	NRC WITH FIBERGLASS INFILL
S02	0.0625"	4.5%	0.6	0.85
S03	0.125"	4.9%	0.55	0.85
S04	0.125"	9.9%	0.65	0.85
S05	0.0625"	10%	0.7	0.9
S06	0.125"	19.6%	0.75	0.9

Sound absorption can be achieved by incorporating acoustic fleece or fiberglass backing. Higher NRC values may be achieved with additional acoustic infill.

FEATURES

- Creates familiar herringbone pattern that is composed through a series of rectangular shapes arranged in a V-shaped formation
- Unlimited finish options – standard and custom solid and wood look colors
- Standard sizes (Herringbone) – See Configuration Options for available size combinations
- Depth up to 3" (1.5" standard)
- Lightweight and easy to install
- Supported by traditional 15/16" HD Grid system
- Integrated Lighting, HVAC and Sprinkler options available
- Torsion spring design allows for easy downward access panel removal
- Suspension Panels drop into the grid and don't require any fasteners

PHYSICAL DATA

- Material substrate – Aluminum (Decorative Panels), Galvanized Steel (Suspension Panels)
- Thickness .041" - .060" design dependent
- Fire Performance - Class A: Tested per ASTM E84, CAN/ULC S102 surface burning characteristics
- Weight - Varies from .67 - 1.10 lbs./sq.ft.
- Warranty – One Year Limited
- Surface Finish - Factory-applied polyester paint. Available in Standard Colors, Color Matched, Wood Look Powder-Coated and Laminated.
- Seismic areas – Mozaix™ has been engineered for use in all seismic areas. Check with local code officials or a licensed engineer for additional requirements.
- Acoustical Options - Perforated panels are supplied with optional acoustic infills to absorb sound

SUSTAINABILITY

CONTRIBUTES TO LEED® POINTS -

- LEED BD+C: New Construction v4
 - ▶ MR: Regional Materials
 - ▶ MR: Recycled Content
- LEED BD+C: Schools v4
 - ▶ EQ: Acoustic Performance
- LEED ID+C: Commercial Interiors v4
 - ▶ EQ: Low-Emitting Materials

- No VOC'S: No added urea-formaldehyde
- EPD 'Environmental Product Declaration' for raw material components
- Recycled Content - up to 80%

LEED® is a registered trademark of the U.S. Green Building Council

Mozaix™ standard design range presents a variety of well-known popular shapes and patterns that enhance the intrigue and depth of ceiling architecture.

STANDARD PATTERNS

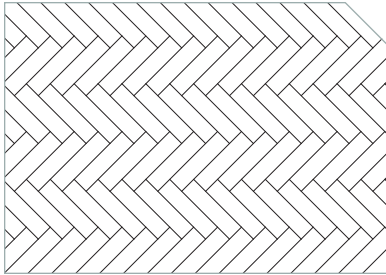

Herringbone

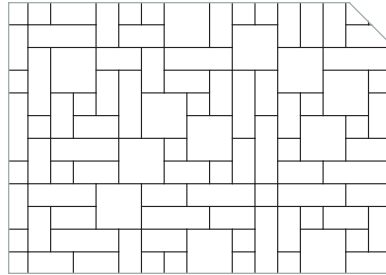

Interlock

Inspired by familiar flooring designs, the Herringbone pattern exudes a timeless elegance, providing both consistency and repetition to the surface. In contrast, Interlock introduces an element of unpredictability and complexity.

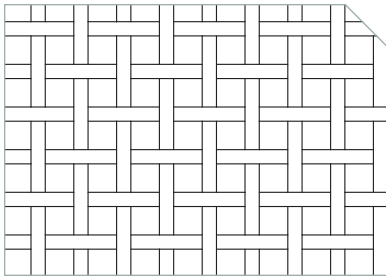

Weave

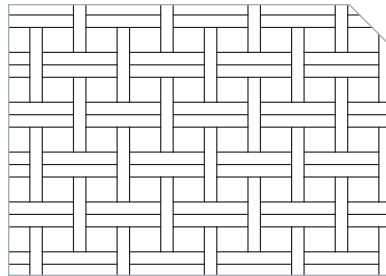

Double Weave

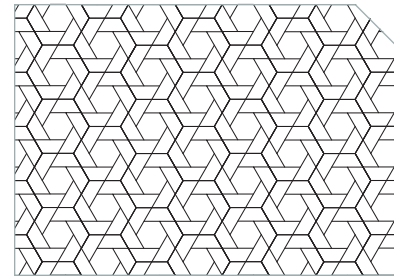

Hex Weave

Weave and Double Weave offer an interlacing effect that suggests interconnectedness, adding depth to the design. Hex Weave provides a bold departure from expected geometry, opening doors to innovative and dramatic effects.

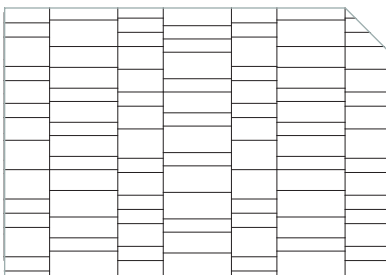

Stacked

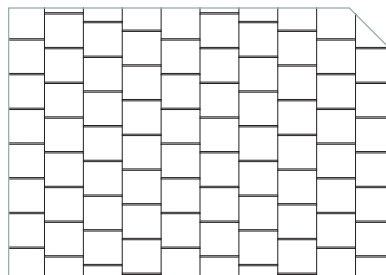

Shift

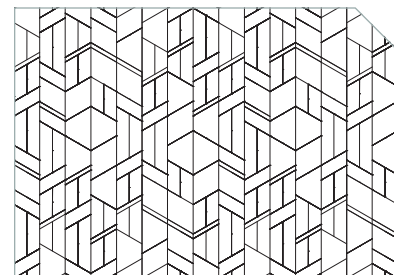

Arrow

Stacked formation deviates from the uniformity of traditional panel designs. Staggered, offset nature of Shift pattern adds unique rhythm and style while celebrating the intricacy of the in-between seams. Arrow symbolizes direction and introduces dynamic movement to any space.

PANELS



NOTHING IS IMPOSSIBLE

Maxxit helps architects and interior designers realize their design intent with creative engineering solutions, a broad range of manufacturing capabilities and unlimited finishing options. From the familiar to the truly one of a kind, Maxxit brings your design vision to life.

Our engineers are masters of metals, wood, felt, glass, composites and more, working in a single medium or combining them in unexpected ways to create stunning architectural solutions. There is no limit to what we can create together.

LINEAR



OPEN CELL

