

**Protero Trilateral Networks** feature triangular beam patterns with optional panels for design versatility.

## MAIN ASSEMBLY ▾

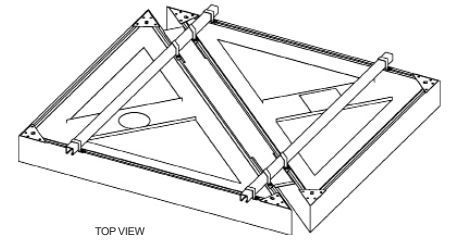
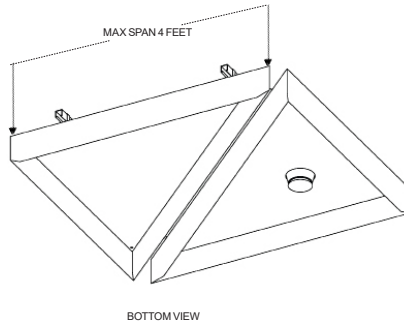

TOP VIEW

PANELS ARE AVAILABLE IN METAL, FELT AND METAL MESH

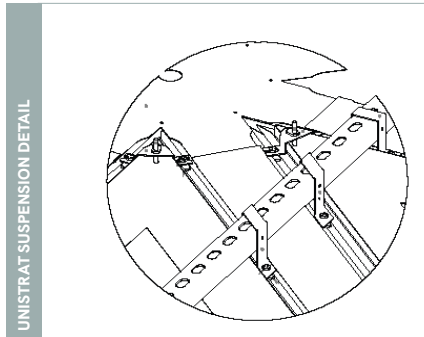
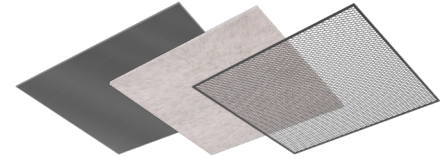

UNISTRUT SUSPENSION DETAIL

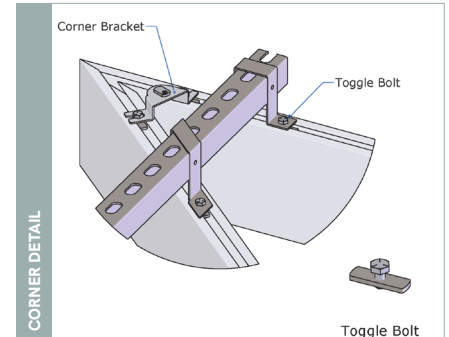

CORNER DETAIL

## PHYSICAL DATA

- Material substrate - Aluminum | Extruded
- Thickness .100"
- Fire Performance - Class A: Tested per ASTM E84. Flame Spread Index 25 or less. Smoke Developed Index 50 or less. CAN/ULC S102 surface burning characteristics. Flame Spread Rating 25 or less. Smoke Developed Classification 50 or less.
- Weight - Varies - 1.03 - 1.92 lbs./ln.ft.
- Warranty - One Year Limited
- Seismic areas - Protero has been engineered for use in all seismic areas. Installations may require additional attachment from baffle to suspension bar. Check with local code officials or a licensed engineer for additional requirements.
- Surface Finish (Beams) - Factory-applied polyester paint. Available in Standard Colors, Color Matched and Wood Look
- Surface Finish (Panels) - Factory-applied polyester paint. Available in Standard Colors, Color Matched, Stainless Steel, Wood Look and Felt colors

## SUSTAINABILITY

### CONTRIBUTES TO LEED® POINTS -

- LEED BD+C: New Construction v4
  - ▶ MR: Regional Materials
  - ▶ MR: Recycled Content
- LEED BD+C: Schools v4
  - ▶ EQ: Acoustic Performance
- LEED ID+C: Commercial Interiors v4
  - ▶ EQ: Low-Emitting Material
- No VOC'S: No added urea-formaldehyde
- EPD 'Environmental Product Declaration' for raw material components
- Recycled Content - Aluminum up to 80%, Felt - minimum 60%

LEED® is a registered trademark of the U.S. Green Building Council. Sustainability certificates are available for aluminum & felt.

## FEATURES

- Extruded beam profiles deliver precise corner execution, resulting in a refined, high-end aesthetic
- Available as open cell or with metal, metal mesh and felt panels
- Integrated lighting options available
- Open-cell design seamlessly accommodates and provides easy access to lighting, sprinklers, and HVAC components
- Metal panels are available perforated with optional acoustic infills
- Standard sizes - In addition to custom we also have quick ship standard products available made to order
  - ▶ Lengths - up to 12'
  - ▶ Standard Size - 1-3/8" x 3-3/8"
  - ▶ Standard Size - 1-1/2" x 6"
  - ▶ Standard Size - 2" x 6"
- Quick ship and expedited shipping
- Versatile attachment options for Unistrut®, custom attachment solutions are available.
- Cleanable using CDC recommended and EPA-approved disinfectants for fog, spray & wipe

# WOOD LOOK FINISHES

## Standard Powder Coated Paint Finishes (Interior & Exterior) Formaldehyde-Free

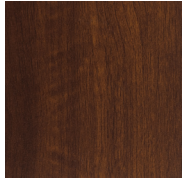

National Walnut



Chestnut

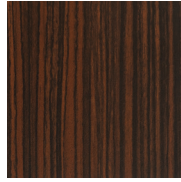

Rosewood



European Cherry



Knotty Pine

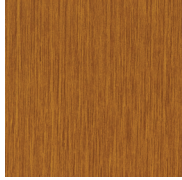

Oak Fine



Maple

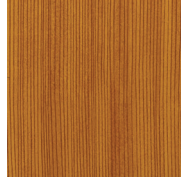

American Douglas



American Maple



Teak

## Custom Colors

### FIND YOUR PERFECT MATCH

At Maxxit we have a passion for finishes; wood, metallic, oil rubbed, whatever your challenge is we can match it!



Send us a color sample so we can quickly provide a color match.

## Standard Laminated (Film) Finishes (interior only). Formaldehyde-free



Canadian Oak



White Oak



American Natural

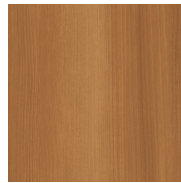

Italian Walnut



North Oak



Black Walnut



Brazilian Walnut

# STAINLESS STEEL FINISHES

Stainless Steel Finishes are only applicable to Panels. For Beams, refer to Solid Colors and Wood Look Finishes.

## Colors

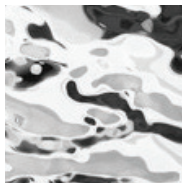

Silver

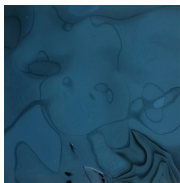

Blue

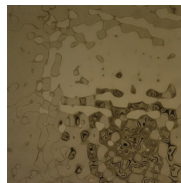

Champagne

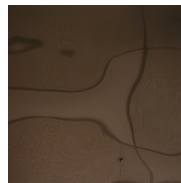

Copper

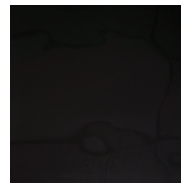

Black

## Textures

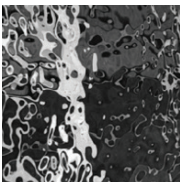

Soft #2

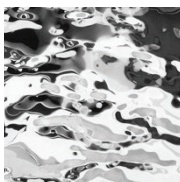

Flow

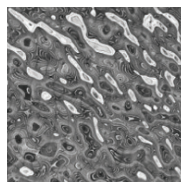









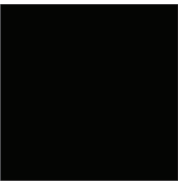
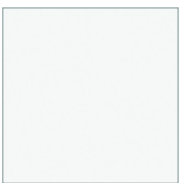
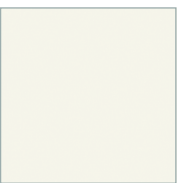

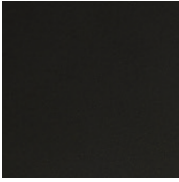
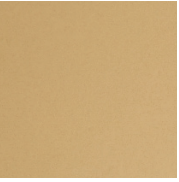

Ripple #2

# STANDARD COLORS

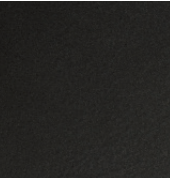
Maxxit powder coat finishes offer superior chemical, scratch and UV resistance, they do not emit VOC's and are available in a broad range of textures, glosses and specialty looks.

## Powder Coated Paint Finishes (Interior & Exterior) Formaldehyde-Free

						
<b>Black</b> (25-35 Gloss)	<b>Snow White</b> (25-30 Gloss)   LRV 83-84	<b>White</b> (17-20 Gloss)   LRV 79-80	<b>Blush Rose</b> (20 Gloss)	<b>Sunrise Yellow</b> (20 Gloss)	<b>Forest Green</b> (20 Gloss)	<b>Pure Orange</b> (20 Gloss)
						
<b>Gold</b> (20 Gloss)	<b>Metallic Bronze</b> (20 Gloss)	<b>Tan Straw</b> (20 Gloss)	<b>Mid Beige</b> (20 Gloss)	<b>Metallic Sterling Silver</b> (20 Gloss)	<b>Charcoal</b> (20 Gloss)	<b>Sterling Silver</b> (20 Gloss)
	<b>Custom Colors</b>					
<b>Grey</b> (65-75 Gloss)	 Custom colors available					

# PANEL PERFORATIONS

Perforations are only applicable to Panels. Protero Beams cannot be perforated.

## Standard Perforations Angles - Staggered 60°

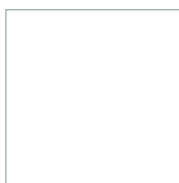
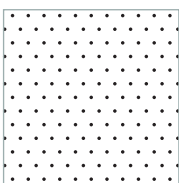
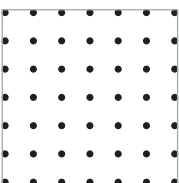
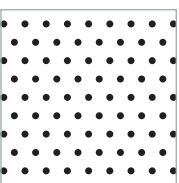
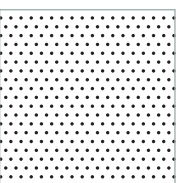
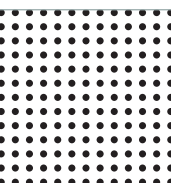
					
<b>Unperforated</b>	<b>S02 Staggered</b> Diameter 0.0625 Open area 4.50% Centers 0.2812	<b>S03 Straight</b> Diameter 0.125 Open area 4.90% Centers 0.5	<b>S04 Staggered</b> Diameter 0.125 Open area 9.90% Centers 0.3788	<b>S05 Staggered</b> Diameter 0.0625 Open area 10.10% Centers 0.1875	<b>S06 Straight</b> Diameter 0.125 Open area 19.60% Centers 0.25

## Premium Perforations Angles - Diagonal 45° | Staggered 60°

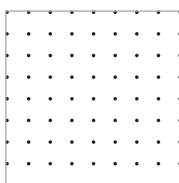
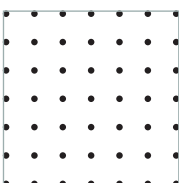
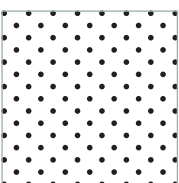
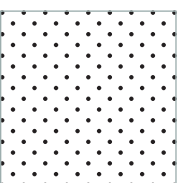
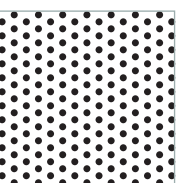
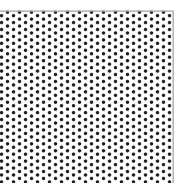
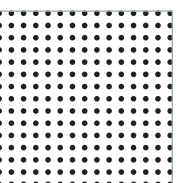
						
<b>P11 Straight</b> Diameter 0.0625 Open area 2.10% Centers 0.3788	<b>P12 Straight</b> Diameter 0.098 Open area 4.14% Centers 0.427	<b>P13 Diagonal</b> Diameter 0.098 Open area 8.28% Centers 0.3019	<b>P14 Diagonal</b> Diameter 0.078 Open area 26.53% Centers 0.1898	<b>P18 Staggered</b> Diameter 0.125 Open area 22.70% Centers 0.25	<b>P19 Staggered</b> Diameter 0.0625 Open area 22.70% Centers 0.125	<b>P21 Straight</b> Diameter 0.098 Open area 16.55% Centers 0.2135



# FELT COLOR SELECTION

Felt is only applicable to Panels. For Beams, refer to Solid Colors and Wood Look Finishes.

## 34 Quick Ship Colors



## Woodgrain Options







# PROTERO DESIGNS

NETWORKS ▾



ELEVATIONS ▾



TRADITIONAL ▾

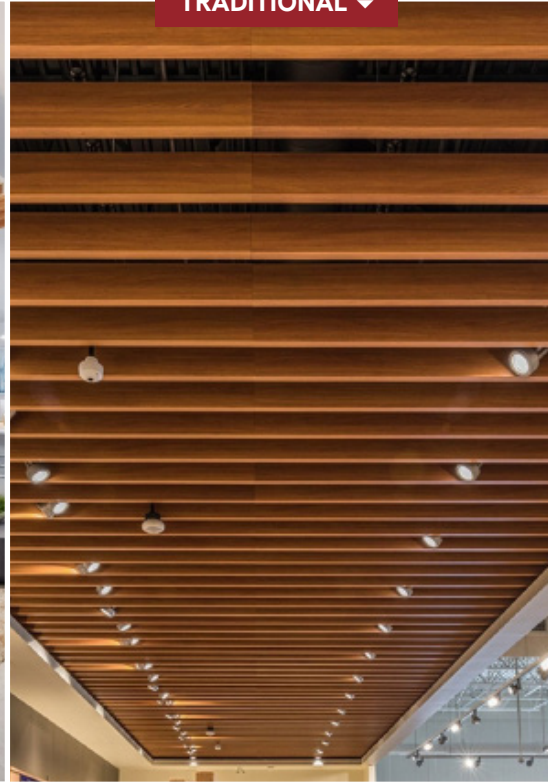

WALL SLATS ▲



PARTITIONS ▲



CONTOUR ▲



# DESIGN REALIZED

From the familiar to the truly one of a kind, Maxxit brings your design vision to life. With ceilings and walls crafted from Wood, Felt, Metal, Composites & more there is no limit to what we can create together.

